

LECTURE NOTES ON
Rapid Prototyping

PREPARED BY

Dr PRAMOD KUMAR PARIDA

ASSISTANT PROFESSOR

DEPARTMENT OF MECHANICAL ENGINEERING
COLLEGE OF ENGINEERING & TECHNOLOGY (BPUT)
BHUBANRSWAR

Syllabus

PEME5303 **RAPID PROTOTYPING** (3-0-0)

Module – I (12 hours)

Product Development: Classification of manufacturing processes, Different manufacturing systems, Introduction to rapid Prototyping (RP), Need of RP in context to batch production, FMS and CIM and its application. Product prototyping – solid modeling and prototype representation, reverse engineering, prototyping and manufacturing using CNC machining.

Basic principles of RP steps in RP, Process chain in RP in integrated CAD-CAM environment, Advantages of RP

Module - II (12 hours)

Rapid Manufacturing Process Optimization: factors influencing accuracy. Data preparation errors, Part building errors, Error in finishing, influence of build orientation.

Classification of different RP techniques based on raw materials, layering technique (2D or 3D) and energy sources.

Process technology and comparative study of stereo lithography (SL) with photopolymerisation, SL with liquid thermal polymerization, solid foil polymerization, selective laser sintering, selective powder binding, Ballistic particle manufacturing – both 2D and 3D, Fused deposition modeling, Shape melting

Module – III (12 hours)

Laminated object manufacturing solid ground curing, Repetitive masking and deposition.

Beam interference solidification, Holographic interference solidification special topic on RP using metallic alloys, Programming in RP modeling, Slicing, Internal Hatching, Surface skin films, support structure.

Software for RP: STL files, Overview of Solid view, magics, imics, magic communicator, etc. Internet based software, Collaboration tools.

Text Book :

1. Rapid Prototyping and Engineering Applications, Frank W. Liou, CRC Press
2. Introduction to Rapid Prototyping, Amitav Ghosh, North West Publication, New Delhi

Reference Books :

1. Rapid Manufacturing, Flham D.T &Dinjoy S.S Verlog London 2001.
2. Rapid Prototyping Materials, Gurumurthi, IISc Bangalore.
3. Rapid Automated, Lament wood. Indus press New York
4. Stereo Lithography and other RP & M Technologies, Paul F. Jacobs: SME, NY 1996.
5. Rapid Prototyping, Terry Wohlers Wohler's Report 2000" Wohler's Association 2000.

Module – I

Manufacturing

The English word manufacture is several centuries old. The term manufacture comes from two

Latin words, manus (hand) and factus (make). As per oxford English dictionary manufacture refers “to make or produce goods in large quantities, using machinery”.

Working definition of manufacturing

There are two types of working definitions available for manufacturing: as a technical process and as an economic process.

Technologically: Manufacturing is the application of physical and chemical processes to alter the geometry, properties and or appearance of a given starting material to make parts or product as shown in Figure

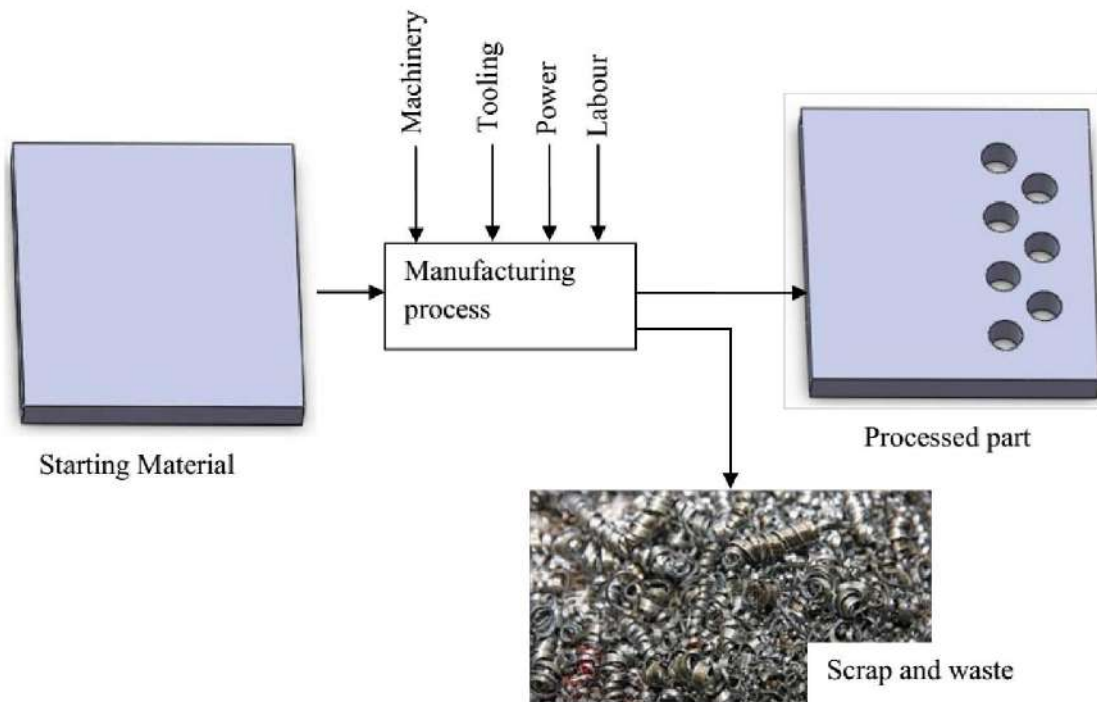

Definition of manufacturing in terms of technology

Economically: Manufacturing is the transformation of materials into items of greater value by means of one or more process and or assembly operation as shown in Figures.

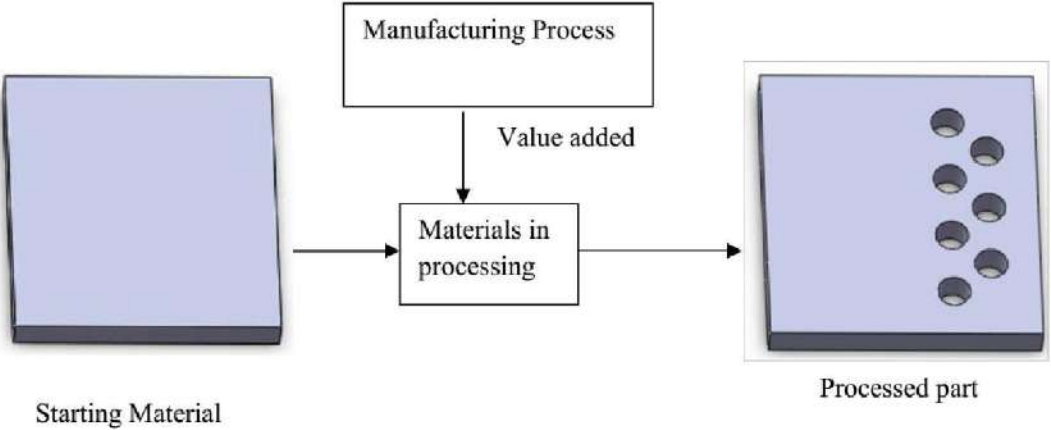

Definition of manufacturing in terms of economic value

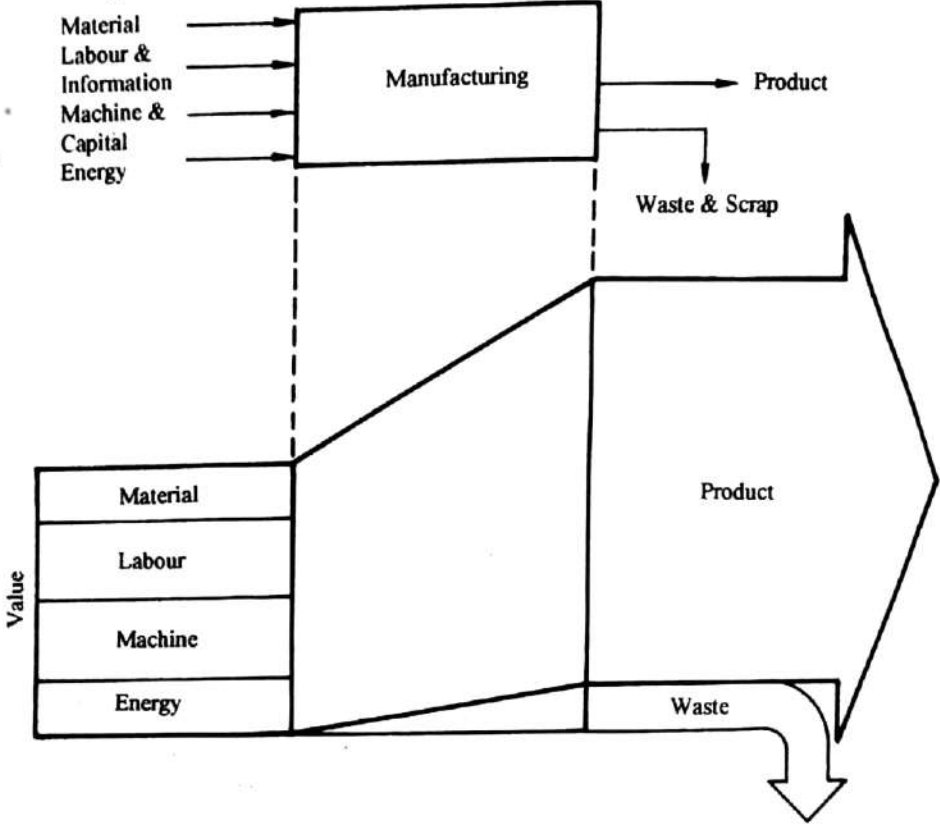

Diagrammatic representation of Manufacturing

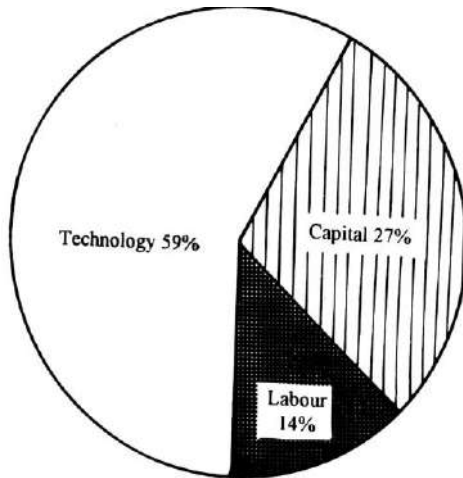

Factors Contributing to Production Growth

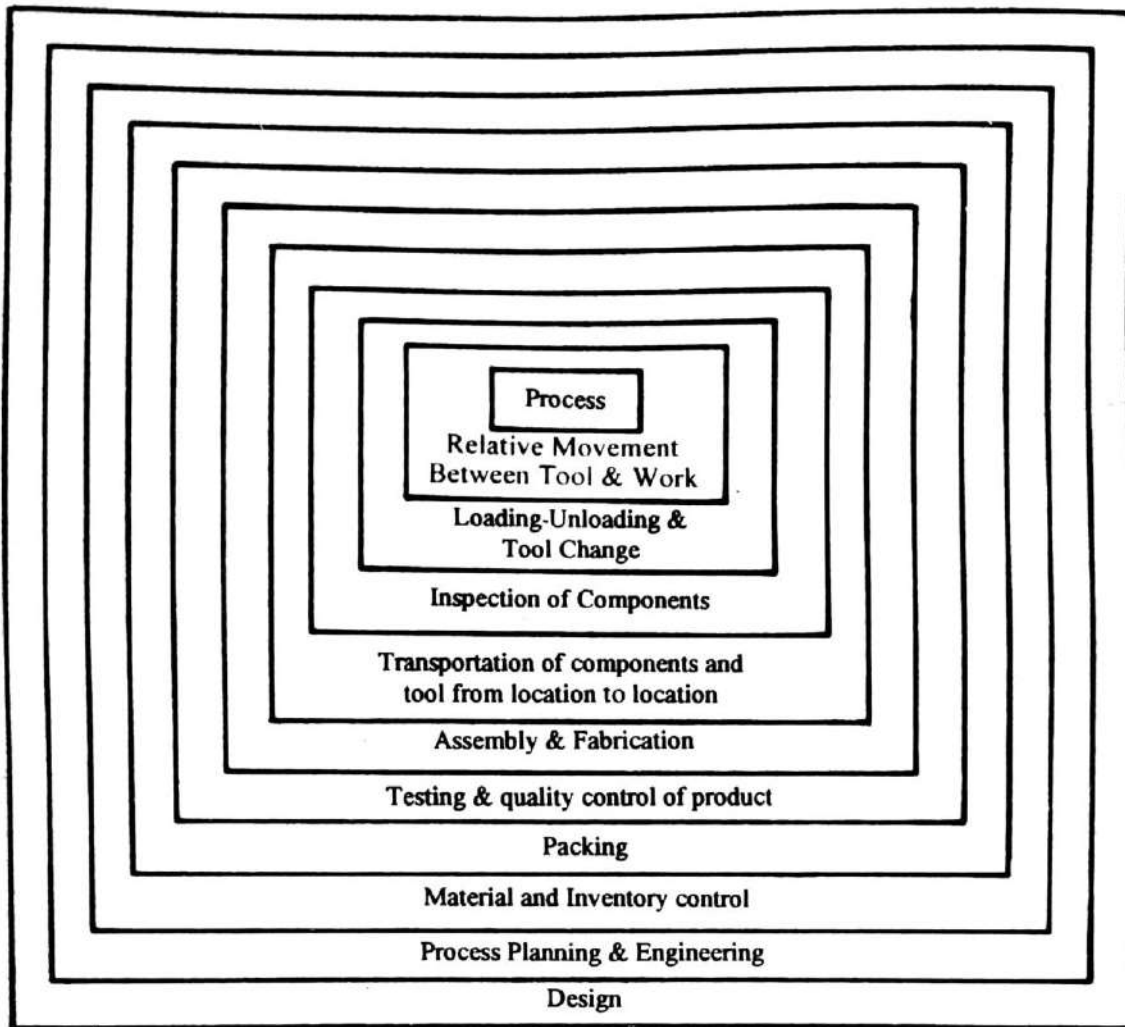

Management & Marketing
Activities involved in Manufacturing

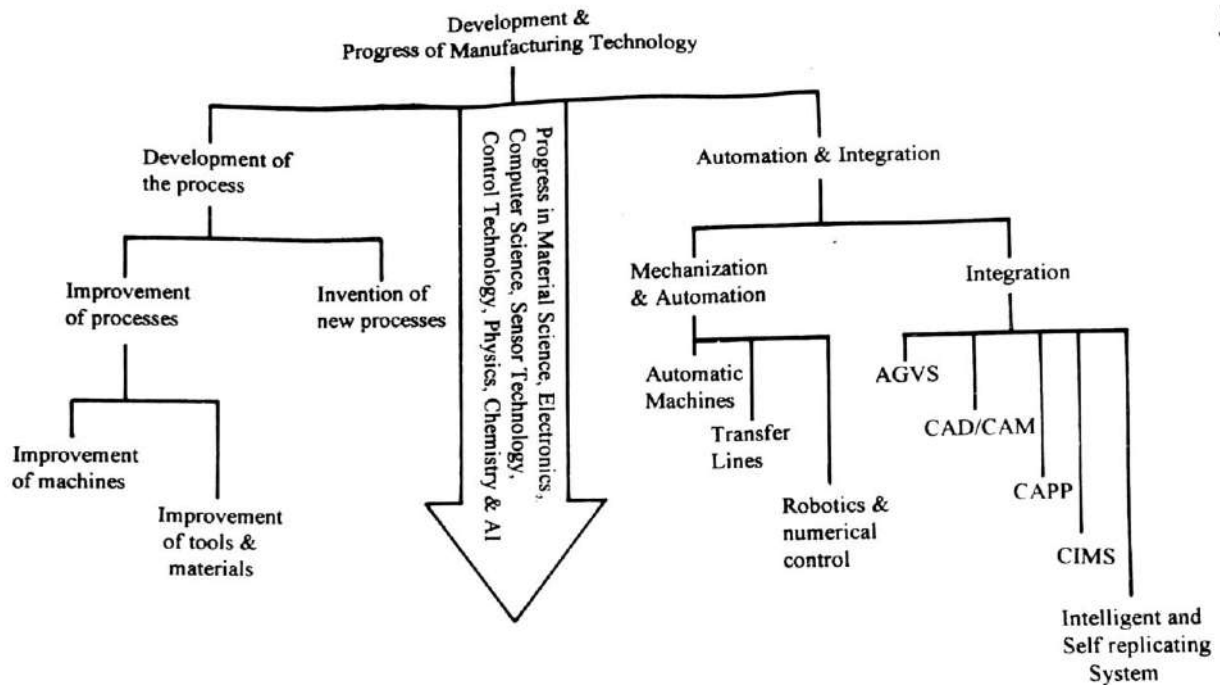

Development and Progress of Manufacturing

Classification of the Manufacturing Process:

- The manufacturing process used in engineering industries basically perform one or more of the following functions:
 - Change the physical properties of the work material
 - Change the shape and size of the work piece.
 - Produce desired dimensional accuracy and surface finish.
- Based on the nature of work involved these processes may be divided into following seven categories:
 1. Processes for changing physical properties of the materials – Hardening, Tempering, Annealing, Surface Hardening.
 2. Casting Processes – Sand Casting, Permanent mold casting, die casting, Centrifugal casting
 3. Primary metal working processes – Rolling, forging, extrusion, wire drawing
 4. Shearing and Forming processes – Punching, blanking, drawing, bending, forming
 5. Joining processes – Welding, brazing, soldering, joining
 6. Machining Processes – Turning, drilling, milling, grinding
 7. Surface finishing processes – Lapping, honing, superfinishing

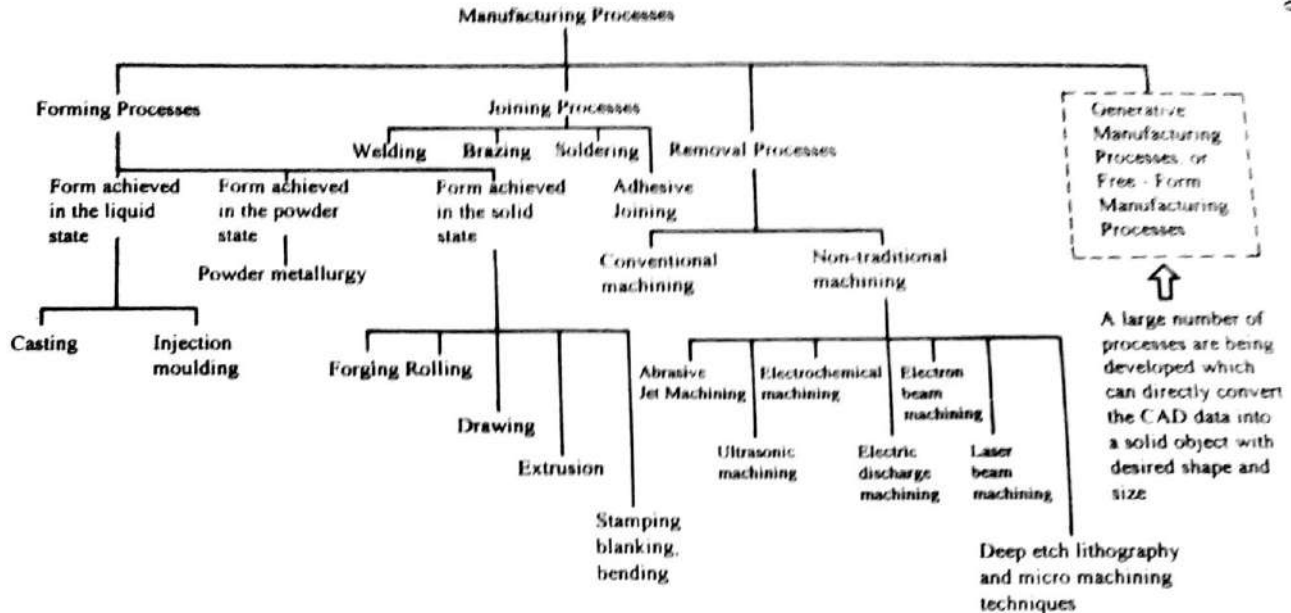

Spectrum of Manufacturing Process

MANUFACTURING SYSTEM

The term manufacturing system refers to a collection or arrangement of operations and processes used to make a desired product or component. It includes the actual equipment for composing the processes and the arrangement of those processes. In a manufacturing system, if there is a change or disturbance in the system, the systems would accommodate or adjust itself and continue to function efficiently. Normally the effect of disturbance must be counteracted by controllable inputs or the system itself. Figure below gives the general definition for any manufacturing system.

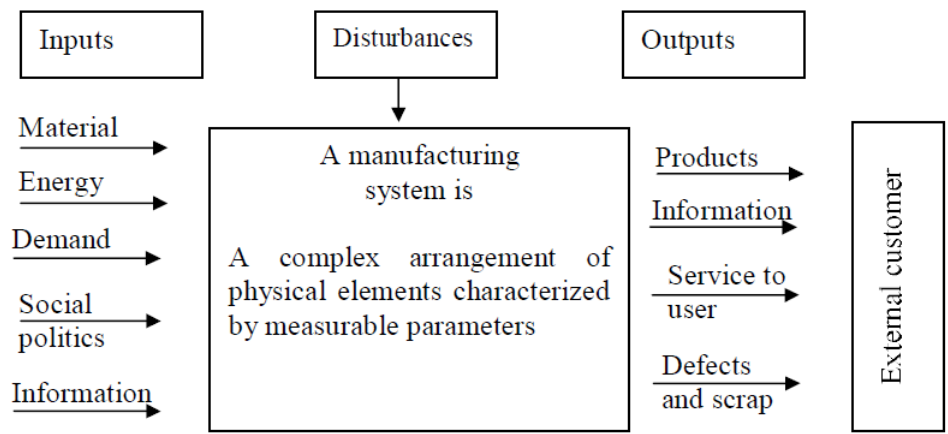

General representation of Manufacturing system

Measurable parameters

- Production rate
- Work in process inventory
- Percentage of defects
- Percentage on time delivery
- Daily/weekly/monthly production volume
- Total cost

Physical elements

- Machines for processing
- Tooling
- Material handling equipment
- People

TYPES OF MANUFACTURING SYSTEMS

The manufacturing systems differ in structure or physical arrangement. According to the physical arrangement, there are four kinds of classical manufacturing systems and two modern manufacturing systems that is rapidly gaining acceptance in industries.

The classical systems are

1. Job shop
2. Flow shop
3. Project shop
4. Continuous process

The modern manufacturing systems are

1. Linked cell system (Cellular manufacturing system)
2. Flexible manufacturing system (FMS)

Job shops

In a Job shop, varieties of products are manufactured in small lot sizes to a specific customer order. To perform a wide variety of manufacturing processes, general purpose production equipment is required. Workers must have relatively high skill levels to perform a range of different work arrangements.

The production machines are grouped according to the general type of manufacturing processes as shown in Figure below. The lathes are in one department, drill presses in another and so on. Each different part requiring

its own sequence of operations can be routed through the various departments in the proper order. For this 'ROUTE SHEETS' are used. The layout made for this purpose is called as functional or process layout.

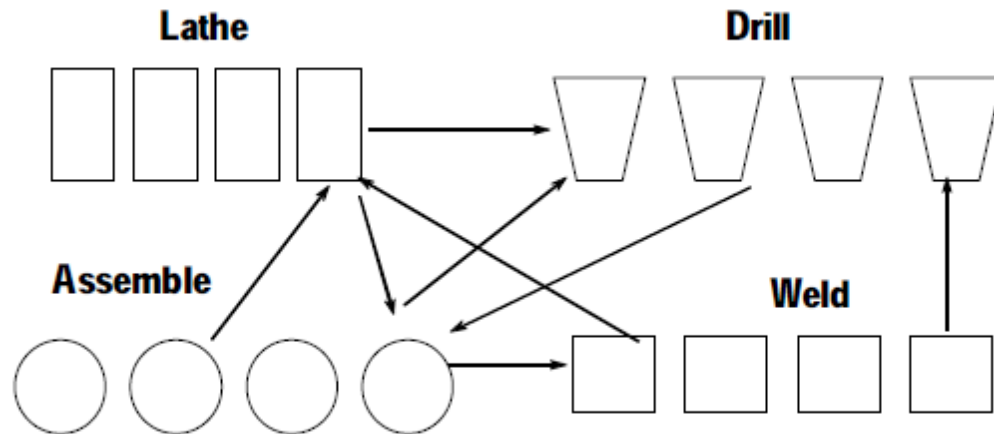

Functional or process layout

Advantages of process layouts

- Can handle a variety of processing requirements
- Not particularly vulnerable to equipment failures
- Equipment used is less costly
- Possible to use individual incentive plans

Disadvantages of process layouts

- In-process inventory costs can be high
- Challenging routing and scheduling
- Equipment utilization rates are low
- Material handling is slow and inefficient
- Complexities often reduce span of supervision
- Special attention for each product or customer
- Accounting and purchasing are more involved

Examples: Machine shops, foundries, press working shops, plastic, industries.

Flow shops

The flow shops have a “product oriented layout” composed mainly of flow lines. This system can have high production rates. The plant may be designed to produce the particular product or family, using “Special purpose machines” rather than general purpose equipment. The skill level of the laborer tends to be lower than in production job shop. When the volume of production becomes large, it is called “mass production”. The material flow is through a sequence of operations by material handling devices. The time the item spends in each station or location is fixed and equal. The workstations are arranged in line according to the processing sequence needed as shown in Figure below

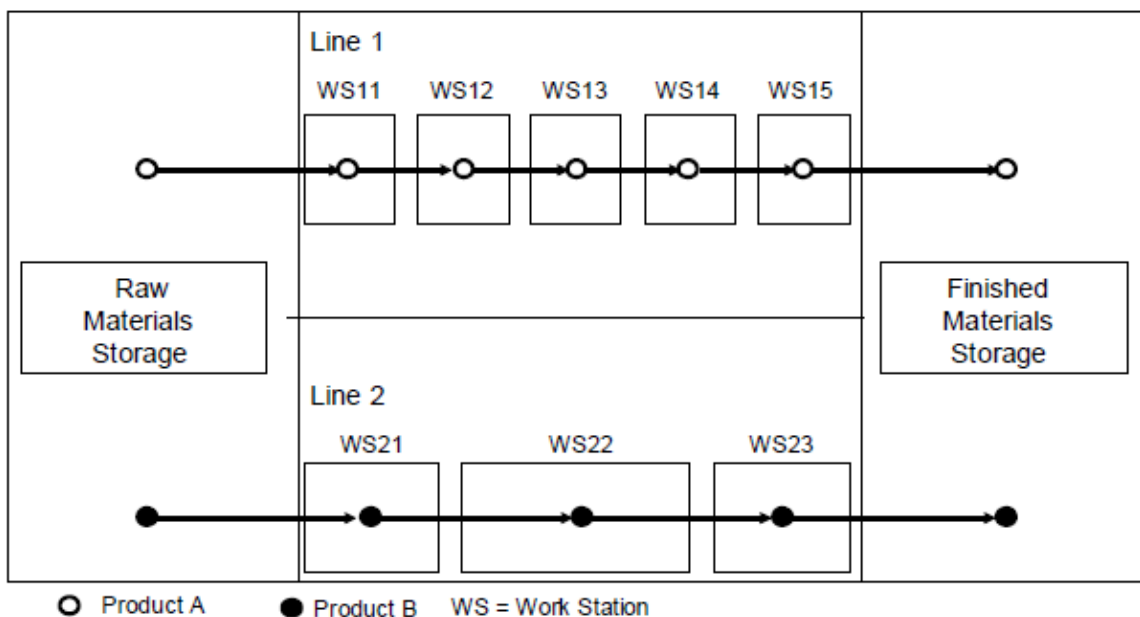

Product layout

Advantages of product layout

- High rate of output
- Low unit cost
- Labor specialization
- Low material handling cost
- High utilization of labor and equipment
- Established routing and scheduling
- Routing accounting and purchasing

Disadvantages of product layout

- Creates dull, repetitive jobs
- Poorly skilled workers may not maintain equipment or quality of output
- Fairly inflexible to changes in volume
- Highly susceptible to shutdowns
- Needs preventive maintenance
- Individual incentive plans are impractical

Example: Automated assembly line and Television manufacturing factory.

Project shop

In this type, a product must remain in a fixed position or location because of its size and weight. The materials, machines and people in fabrication are brought to site. The layout is also called as fixed position layout. Figure below shows the project shop layout.

Example: Locomotive manufacturing, large aircraft assembly and shipbuilding

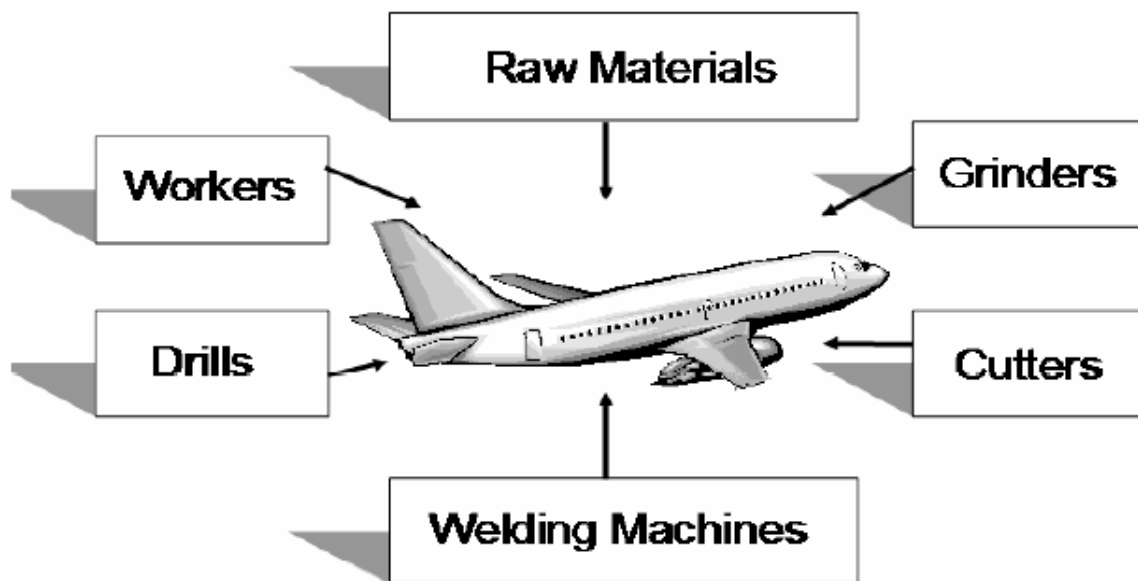

Project shop layout

Advantages of project layout

- Minimum capital investment
- Continuity of operation

- Less total production cost.
- Offers greater flexibility
- Allows the change in production design.
- Permits a plant to elevate the skill of its operators

Disadvantages of project layout

- Machines, tools and workers take more time to reach the fixed position.
- Highly skilled workers are required.
- Complicated jigs and fixtures (work holding device) may be required.

Continuous process

In this continuous process, the product seems to flow physically. This system is sometimes called as flow production when referring to the manufacture of either complex single parts, such as scanning operation, or assembled products such as TVs. However, this is not a continuous process, but high volume flow lines. In continuous process, the products really do flow because they are liquids, gases, or powers. Figure 1.5 shows the continuous process layout. It is the most efficient but least flexible kind of manufacturing system. It usually has the leanest and simplest production system because this manufacturing system is the easiest to control because it has the least work- in progress(WIP).

Examples: Oil refineries, chemical process plants and food processing industries

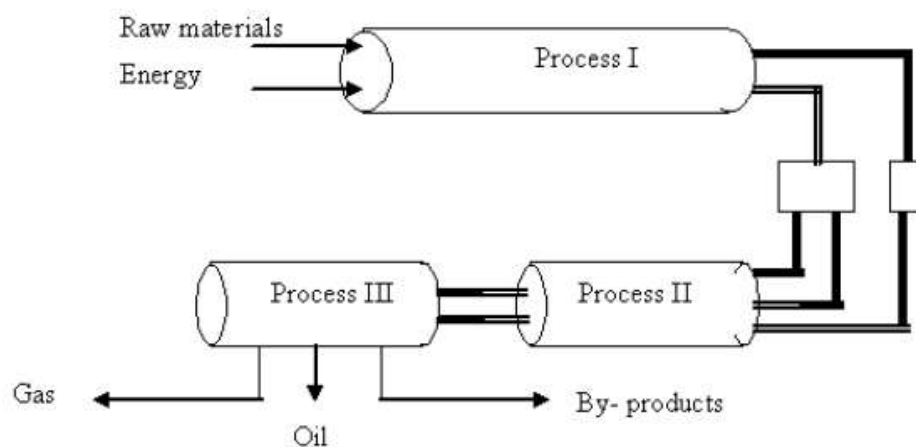

Continuous process layout

Linked cell manufacturing system

Cellular manufacturing (CM) is a hybrid system for linking the advantages of both job shops (flexibility in producing a wide variety of products) and flow lines (efficient flow and high production rate). A cellular manufacturing system (CMS) is composed of “linked cells”. Figure below shows the main structure of cellular manufacturing system. In cells, the workstations are arranged like a flow shop. The machines can be modified, retooled and regrouped for different product lines within the same “family” of parts. This system has some degree of automatic control for loading and unloading of raw materials and work pieces, changing of tools, transferring of work pieces and tools between workstations. Cells are classified as manned and unmanned cells. In manned cells multifunctional operators can move from machine to machine and the materials can be moved by the operator. In the unmanned cells, an industrial robot is located centrally in the cell for material handling. Automated inspection and testing equipment can also be a part of this cell.

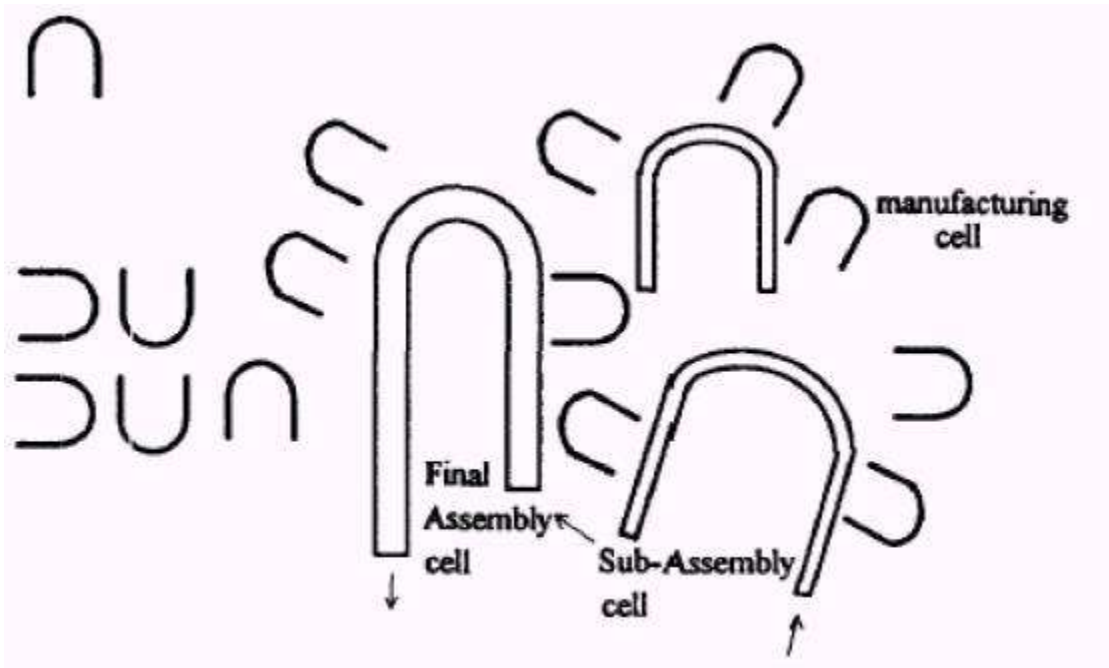

Main structure of cellular manufacturing System

Advantages of CMS

The advantages derived from CMS in comparison with traditional manufacturing systems in terms of system performance have been discussed in Farrington (1998), Kannan (1999), Suresh (2000), Hug (2001) and Assad (2003). These benefits have been established through simulation studies, analytical studies, surveys, and actual implementations.

They can be summarized as follows:

Setup time is reduced: A manufacturing cell is designed to handle parts having similar shapes and relatively similar sizes. For this reason, many of the parts can employ the same or similar holding devices (fixtures). Generic fixtures for a part family can be developed so that time required for changing fixtures and tools is decreased.

Lot sizes are reduced: Once setup times are greatly reduced in CM, small lots are possible and economical. Small lots also provide smooth production flow.

Work-in-process (WIP) and finished goods inventories are reduced: With smaller lot sizes and reduced setup times, the amount of WIP can be reduced. The WIP can be reduced by 50% when the setup time is cut to half. In addition to the reduced setup times and WIP inventory, finished goods inventory is reduced. Instead of make-to-stock systems with parts either being run at long, fixed intervals or random intervals, the parts can be produced either JIT in small lots or at fixed, short intervals.

Material handling costs and time are reduced:

In CM, each part is processed completely within a single cell (wherever possible). Thus, part travel time and distance between cells is minimal.

A reduction in flow time is obtained:

Reduced materials handling time and reduced setup time greatly reduce flow time.

Tool requirements are reduced:

Parts produced in a cell are of similar shape, size, and composition. Thus, they often have similar tooling requirements.

A reduction in space required:

Reductions in WIP, finished goods inventories, and lot sizes lead to less space required.

Throughput times are reduced:

In a job shop, parts are transferred between machines in batches. However, in CM each part is transferred immediately to the next machine after it has been processed. Thus, the waiting time is reduced substantially.

Product quality is improved:

Since parts travel from one station to another as single unit, they are completely processed in a small area. The feedback is immediate and the process can be stopped when things go wrong.

Better overall control of operations:

In a job shop, parts may have to travel through the entire shop. Scheduling and material control are complicated. In CM, the manufacturing facility is broken down into manufacturing cells and each part travels with a single cell, resulting in easier scheduling and control.

Flexible manufacturing system

A FMS integrates all major elements of manufacturing into a highly automated system. The flexibility of FMS is such that it can handle a variety of part configurations and produce them in any order. Figure 1.7 shows flexible manufacturing system. The basic elements of FMS are a) works station b) automated material handling and automated storage and retrieval systems c) control systems. Because of major capital investment; efficient machine utilization is essential. Consequently, proper scheduling and process planning are crucial, that are complex in nature. Because of the flexibility in FMS, no setup time is wasted in switching between manufacturing operations; the system is capable of different operations in different orders and on different machines.

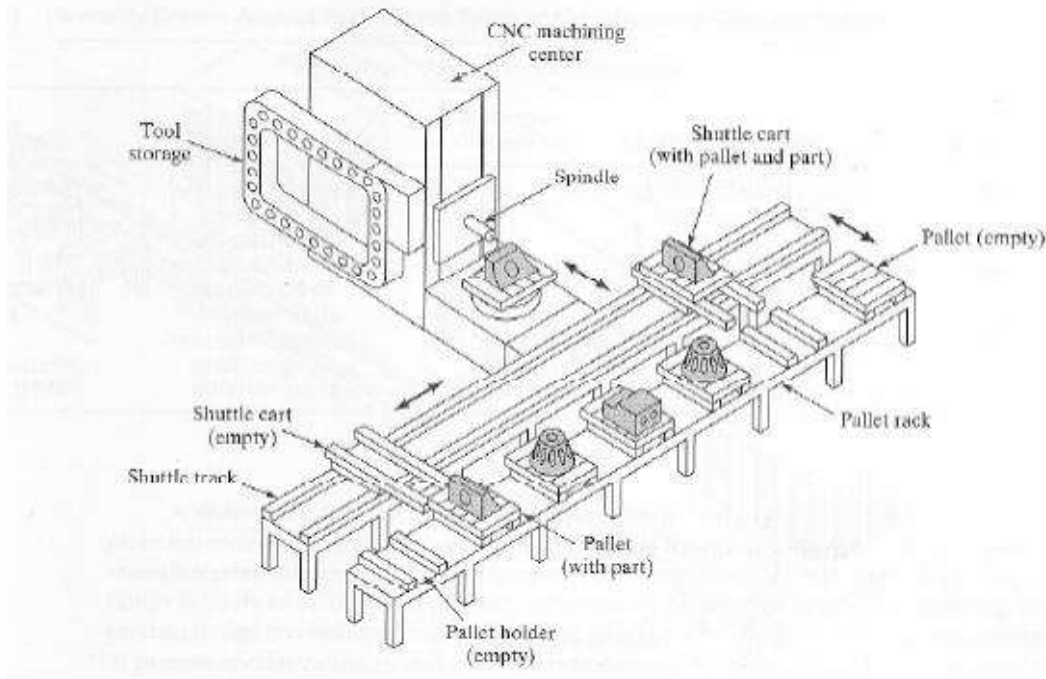

Flexible manufacturing system

Advantages:

- Parts can be produced randomly in batch sizes, as small as one, and at lower cost.
- The lead times required for product changes are shorter
- Reduced WIP
- Labour and inventories are reduced
- Production is more reliable, because the system is self-correcting and so product quality is uniform.
- Increased machine utilization
- Fewer machines required
- Reduced factory floor space
- Greater responsiveness to change

Automation:

With the advent of mass manufacturing concept, the fruits of technology have reached the common man. Without mass production, cost of the products would have kept several items, which are now common, far beyond the reach of most people. To increase the productivity hence lower the production cost as much as possible automation was introduced in the engineering manufacturing industries. At the onset such automation was primarily named as Automatic Mechanization. These specially designed manufacturing units could be cost effective only when huge quantity of a particular item was needed to be manufactured. The variations in products were few and the demand for individual items was large. Thus this type of automation now- a-days called '**Hard Automation**'.

In the 1940's the concept of computer emerged and that led to the development of 'numerical control' for machine tools. Changing a set-up for switching over from one job to another involved changing a substantial amount of the hardware i. e. cams, fixtures, tooling etc. it was time consuming and was expensive also. Once the concept of computer developed it becomes possible to store and feed information with the help of numbers. Numerical control (NC) implies that the necessary information for producing a particular component in a machine can be provided with the help of numbers. Thus switching over from one job to another involved feeding new data and no major modification of the hardware is necessary. Consequently, such units are very flexible in the sense that switching over from one job to another can be done without major time delay and expense. Use of such flexible machines is termed as '**Flexible Automation**'. With the tremendous development in computer science and micro-electronics, flexible automation has become very inexpensive to achieve. The machines are also now directly controlled by computers and such a control is called '**Computer Numerical Control (CNC)**'

It is easy to visualize that with the help of such flexible automation, the requirement of specialized hardware for automatic production of a particular item is eliminated. Cost effective automatic manufacturing has hence become feasible even for small and medium size batches. Figure below indicates the cost effectiveness of different types of manufacturing automation for different ranges of production.

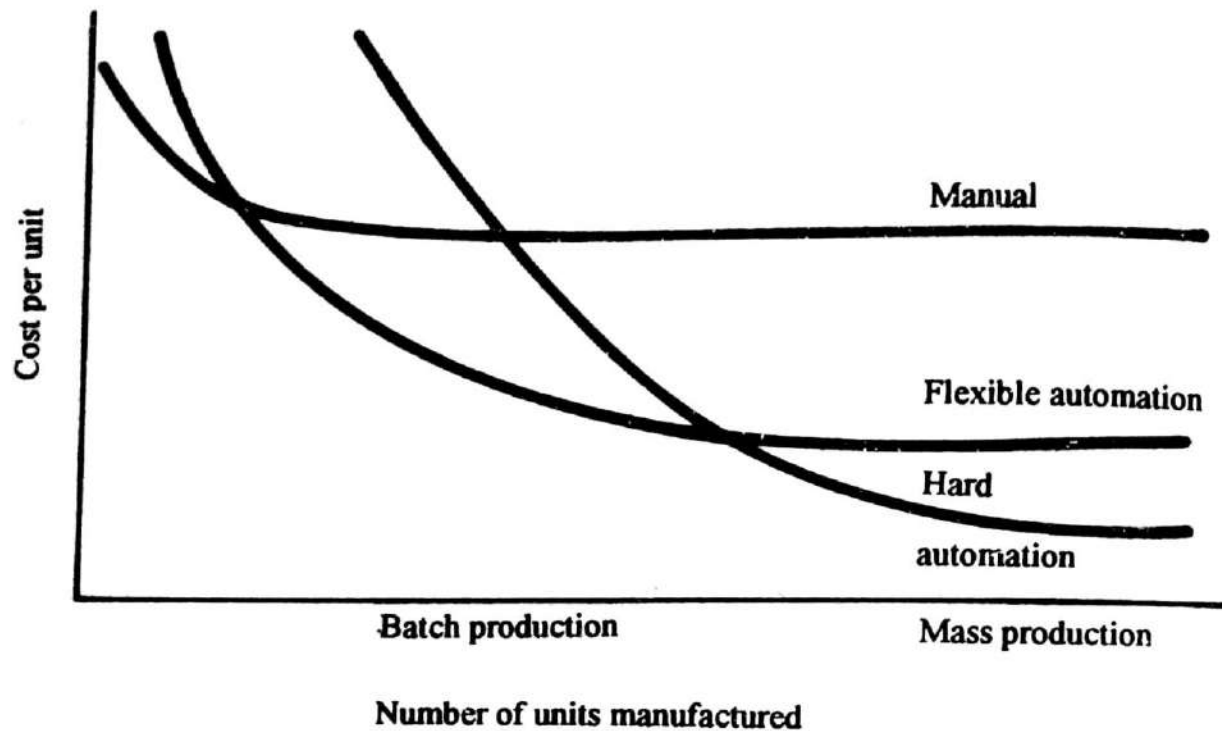

Cost effectiveness of different types of manufacturing automation

Along with the progress in computers, microelectronics and sensor technology gradually appeared in the technological world i.e. '**Industrial Robotics**'. With the development of industrial robots, manufacturing industry entered another era where it became possible to realize the dream of true automation. The human work force for tending machines and inspection stations and more important assembly stations could now be replaced by industrial robots. Figure below shows the various stages of mechanization and automation in the engineering manufacturing industry.

Pre-Industrial
Revolution

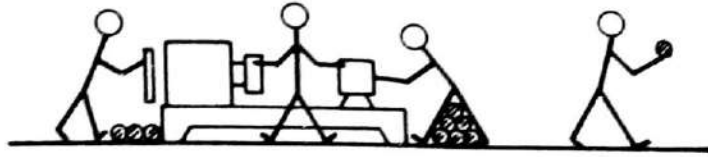

First
Industrial
Revolution

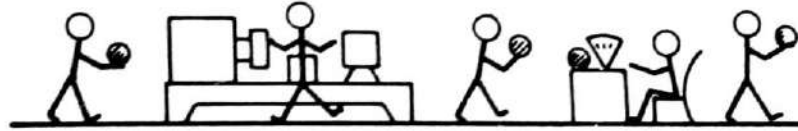

Semiautomatic
Production
Machines

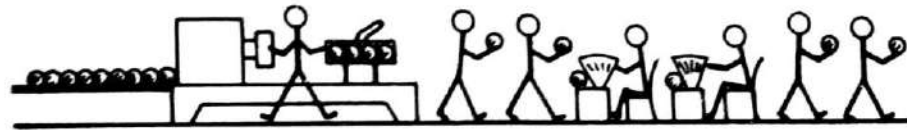

Automatic
Machines
& Transfer
Line



Flexible
Automation
& Computer
Integration



Stages of Mechanization in Manufacturing

The use of computers in assisting manufacturing started before CAD developed as useful tool. In the early days the use of computers in extending the applications of NC technology, specially to part programming, was termed as computer aided manufacturing (CAM) and it was delinked from the design activities. Initially CAD and CAM evolved as separate activities, but gradually it became evident that certain tasks were common to both. Use of CAD/CAM in an effective manner helps to improve the design as manufacturing considerations can be incorporated into the design. A substantial amount of improvement in productivity and quality has

been found to be possible through the use of CAD/CAM technology. Figure below shows the scheme for CAD/CAM in a modern industry.

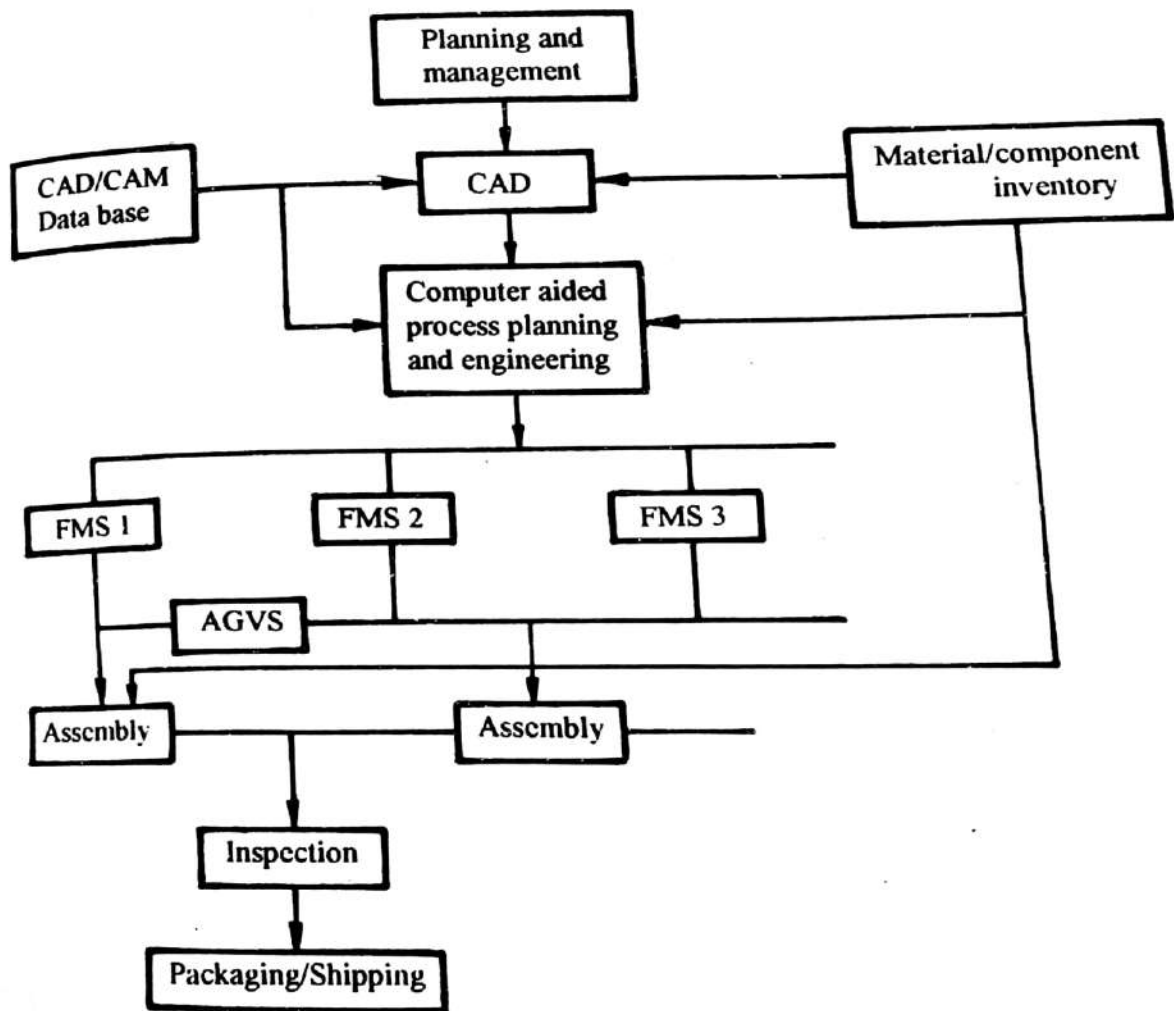

Basic scheme of a manufacturing industry using CAD/CAM

Though the application of computers in manufacturing became quite extensive, the various associated activities still remained compartmentalized and distinct. Once the technology of flexible automation matured integration of the different activities became feasible.

Computer Integrated Manufacturing (CIM)

In a very competitive and open global market survival is possible only if a good product variety is offered, quality and reliability are assured, cost is made attractive and the time gap between the conceptualization of a product and delivery is reduced. To satisfy so many requirements it is essential to strive for optimal use of man, machine and material. This is possible only if all the activities associated with design and manufacturing are integrated. As mentioned earlier the required electromechanical and computer technologies for such an integration was ready in 80's. such a system is termed as 'computer integrated manufacturing system'(CIMS) and the technology has been given the name 'computer integrated manufacturing (CIM)'. CIM not only implies the use of computer in designing a product, planning inventory and production, controlling the operations and accomplishing many other designs, manufacturing, management and business information related issues but suggest a marriage of the diverse functions under the control of one central supervisory computer. The figure below indicates the information flow, material flow and functions involved in CIM.

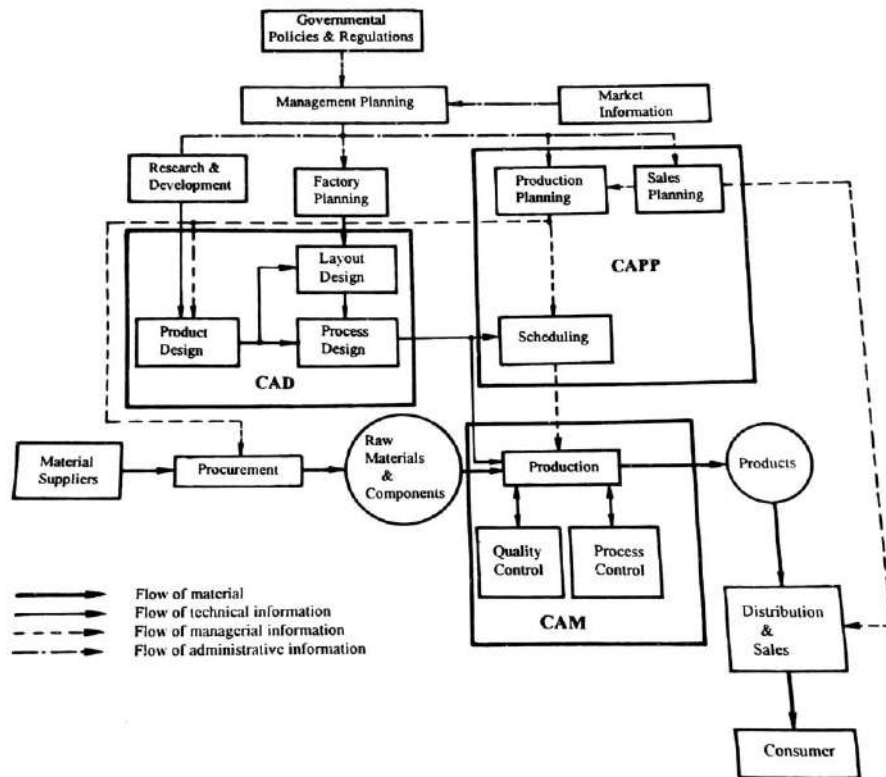

Structure of CIM

In **concurrent engineering (CE)** product is developed by a team involving engineers from both the design section and the production shop. The advantages of concurrent engineering are based on the economic leverage of addressing all aspects of design of a product as early as possible. Hence using concurrent engineering most of the design modification is incorporated as early as possible. It is also true that the importance of early modification is very significant and the ability of the early change to influence the product cost is much larger as indicated. Hence using concurrent engineering most of the design modifications are incorporated as early as possible.

The duration of prototype development is an important factor and it is found that more than 25% of the total product development time goes in fabricating the prototype. The figure below shows the typical duration of product development and prototype fabrication.

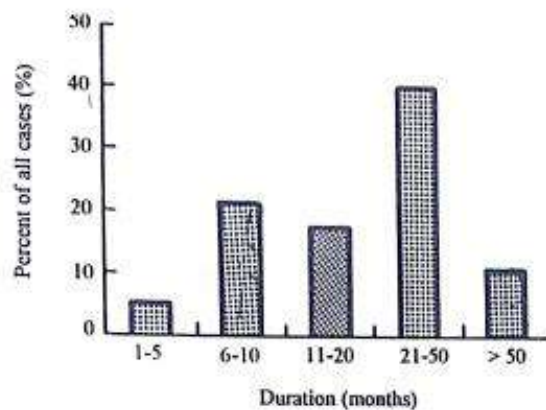

(a)

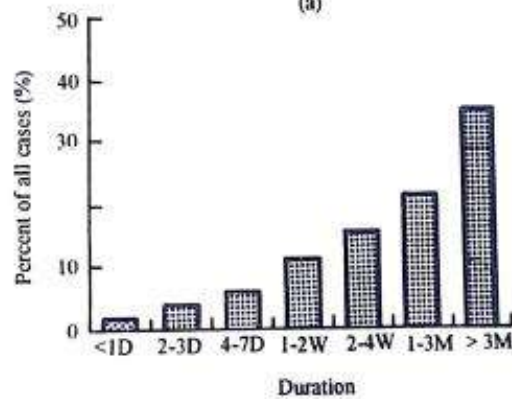

(a) Typical duration of product development, (b) typical duration of prototype development

Figure below indicates the product development cycle and the prototype for different stages.

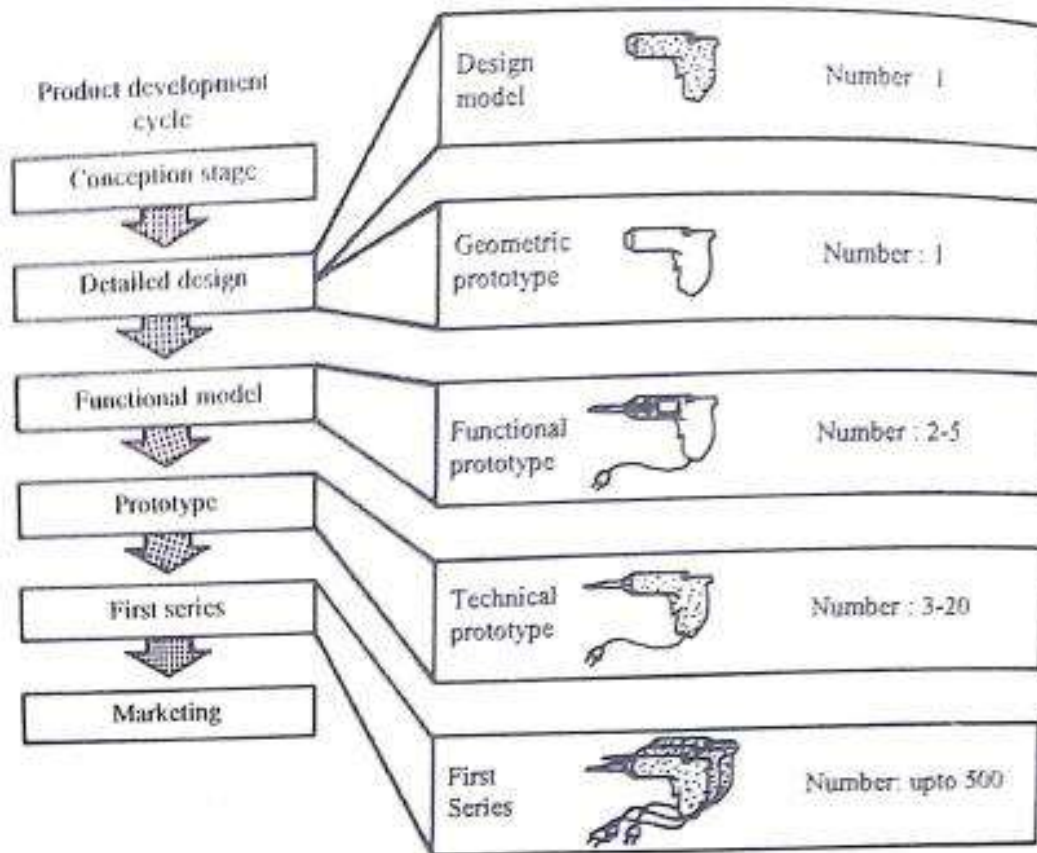

Types of prototypes at different stages of product development

- In the early stage of product development a 'design model' and a 'geometric prototype' are prepared. The design model is made primarily to decide the overall appearance and it is used for ergonomics analysis. Since there is no functional requirement these models are easy to process, non metallic materials can be used for making these models.
- In geometric prototypes the dimensional features of the product, accuracy and tolerances are of primary importance. These prototypes are also made of model making materials as functional aspects are of secondary importance. These prototypes are used primarily for process planning. Appearance and many geometric features are not considered at this stage.

- In the next step technical prototypes are made using the same material and the same manufacturing processes as the intended final product. The technical prototypes are useful in assessing various product qualities like reliability, product life etc.
- After the necessary modifications the first series of the product is manufactured and marketed.

Rapid Prototyping (RP)

Though the principle of concurrent engineering (CE) is quite clear and the advantages of the concept for improved quality and reduced cost are implicit, it is not possible to incorporate CE effectively in the absence of some technique for quick development of prototype. To reduce the development time and adopt concurrent engineering in its true spirit, quick and inexpensive fabrication of prototype parts is essential and rapid prototyping technology has made that possible.

A family of unique fabrication processes developed to make engineering prototypes in minimum lead time based on a CAD model of the item

•The traditional method is machining

–Machining can require significant lead-times –several weeks, depending on part complexity and difficulty in ordering materials

•RP allows a part to be made in hours or days given that a computer model of the part has been generated on a CAD system

WYSIWYG-*What You See Is What You Get*

Why Rapid Prototyping?

•Because product designers would like to have a physical model of a new part or product design rather than just a computer model or line drawing

–Creating a prototype is an integral step in design

–A *virtual prototype* (a computer model of the part design on a CAD system) may not be sufficient for the designer to visualize the part adequately

–Using RP to make the prototype, the designer can visually examine and physically feel the part and assess its merits and shortcomings

Reverse Engineering:

In today's intensely competitive global market, product enterprises are constantly seeking new ways to shorten lead times for new product developments that meet all customer expectations. In general, product enterprise has invested in CAD/CAM, rapid prototyping, and a range of new technologies that provide business benefits. Reverse engineering (RE) is now considered one of the technologies that provide business benefits in shortening the product development cycle. Figure below depicts how RE allows the possibilities of closing the loop between what is "as designed" and what is "actually manufactured".

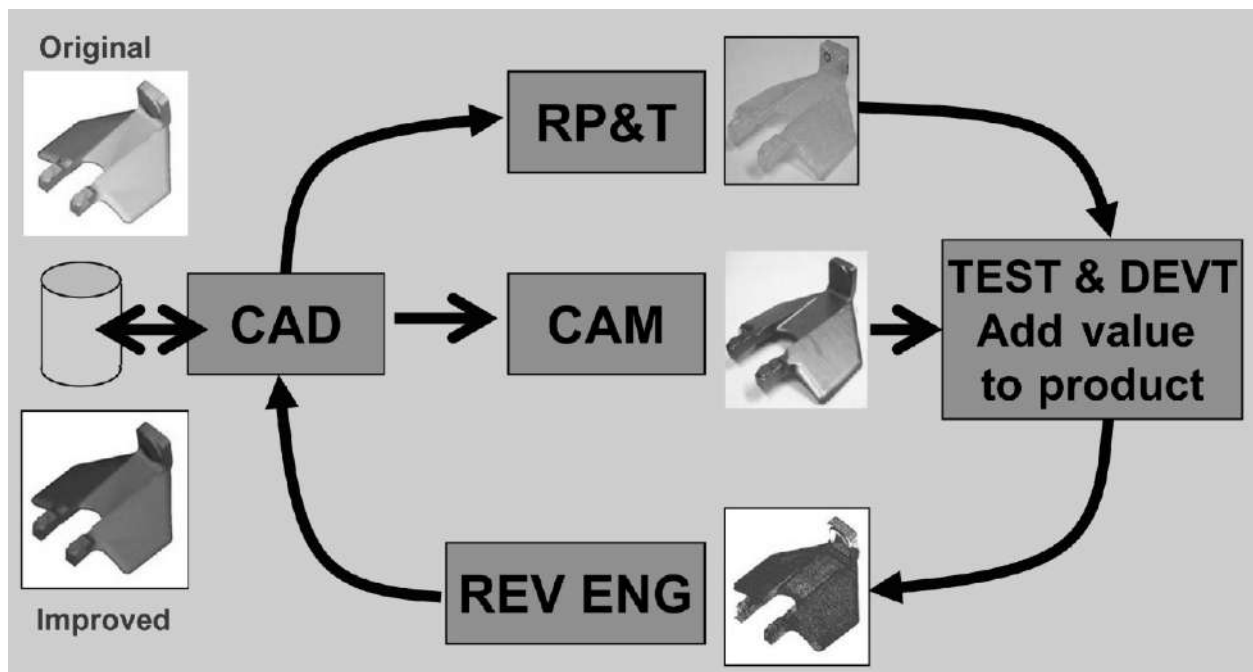

Product development cycle

What Is Reverse Engineering?

Engineering is the process of designing, manufacturing, assembling, and maintaining products and systems. There are two types of engineering, forward engineering and reverse engineering. Forward engineering is the traditional process of moving from high-level abstractions and logical designs to the physical implementation of a system. In some situations, there may be a physical part/product without any technical details, such as drawings, bills-of-material, or without engineering data. The process of duplicating an existing part, subassembly, or product, without drawings,

documentation, or a computer model is known as reverse engineering. Reverse engineering is also defined as the process of obtaining a geometric CAD model from 3-D points acquired by scanning/digitizing existing parts/products. The process of digitally capturing the physical entities of a component, referred to as reverse engineering (RE), is often defined by researchers with respect to their specific task.

Reverse engineering is now widely used in numerous applications, such as Manufacturing, industrial design, and jewelry design and reproduction. For example, when a new car is launched on the market, competing manufacturers may buy one and disassemble it to learn how it was built and how it works. In software engineering, good source code is often a variation of other good source code. In some situations, such as automotive styling, designers give shape to their ideas by using clay, plaster, wood, or foam rubber, but a CAD model is needed to manufacture the part. As products become more organic in shape, designing in CAD becomes more challenging and there is no guarantee that the CAD representation will replicate the sculpted model exactly.

Reverse engineering provides a solution to this problem because the physical model is the source of information for the CAD model. This is also referred to as the physical-to-digital process depicted in Figure 1.2. Another reason for reverse engineering is to compress product development cycle times. In the intensely competitive global market, manufacturers are constantly seeking new ways to shorten lead times to market a new product.

Rapid product development (RPD) refers to recently developed technologies and techniques that assist manufacturers and designers in meeting the demands of shortened product development time. For example, injection-molding companies need to shorten tool and die development time drastically. By using reverse engineering, a three-dimensional physical product or clay mock-up can be quickly captured in the digital form, remodeled, and exported for rapid prototyping/tooling or rapid manufacturing using multi-axis CNC machining techniques.

Why Use Reverse Engineering?

Following are some of the reasons for using reverse engineering:

- The original manufacturer no longer exists, but a customer needs the product,
e.g., aircraft spares required typically after an aircraft has been in service for several years.
- The original manufacturer of a product no longer produces the product, *e.g.*, the original product has become obsolete.
- The original product design documentation has been lost or never existed.
- Creating data to refurbish or manufacture a part for which there are no CAD data, or for which the data have become obsolete or lost.
- Inspection and/or Quality Control—Comparing a fabricated part to its CAD description or to a standard item.
- Some bad features of a product need to be eliminated *e.g.*, excessive wear might indicate where a product should be improved.
- Strengthening the good features of a product based on long-term usage.
- Analyzing the good and bad features of competitors' products.
- Exploring new avenues to improve product performance and features.
- Creating 3-D data from a model or sculpture for animation in games and movies.
- Creating 3-D data from an individual, model or sculpture to create, scale, or reproduce artwork.
- Architectural and construction documentation and measurement.
- Fitting clothing or footwear to individuals and determining the anthropometry of a population.

Module - II

Basic principles of RP

- In this process a solid object with prescribed shape, dimension and finish can be directly produced from the CAD based geometric model data stored in a computer without human intervention.
- Conventional method for producing parts like casting, forming, machining etc are not suitable for this purpose and a host of new processes for shaping objects directly from the CAD data have been developed and machines are in the market.

Rapid prototyping can be of two types:

- The parts obtained by RP technology can form the prototype directly without requiring any further processing.
- The parts obtained by RP technology can be used to make moulds for casting the prototype component. This type is needed because till today, the commercially available RP machines are non metallic materials with low strength and low melting temperature.

In general this technology is called as Generative manufacturing Process (GMP) as the shape of the work piece is not obtained by removal of chips or forming or casting. It is achieved by addition of material without any prior recognizable form or shape and no tool is necessary.

In all types of GMPs the CAD model is split into layers as indicated figure below.

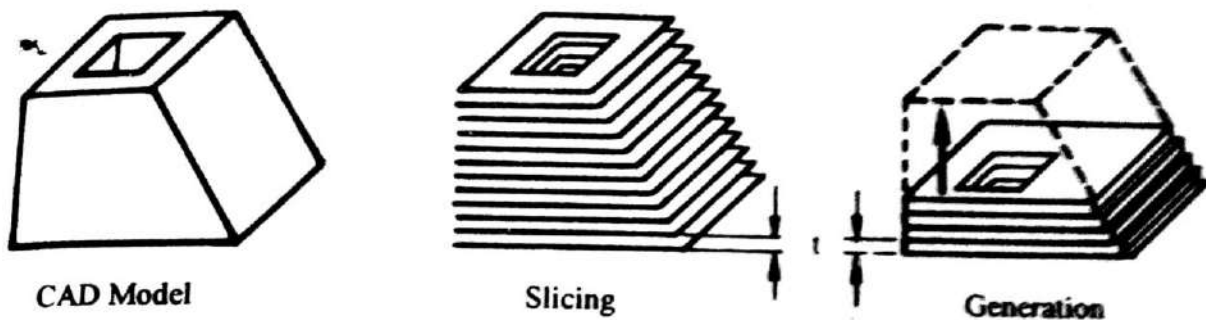

Basic principle of the GMP

- The slice thickness and slicing direction can be varied for convenience of generation.
- To generate an object of same shape as that of sliced CAD model, the distance between the slicing planes (t) must be equal to the thickness of the corresponding layers during the actual generation process.

The general procedure for obtaining a solid component from a CAD file is shown below:

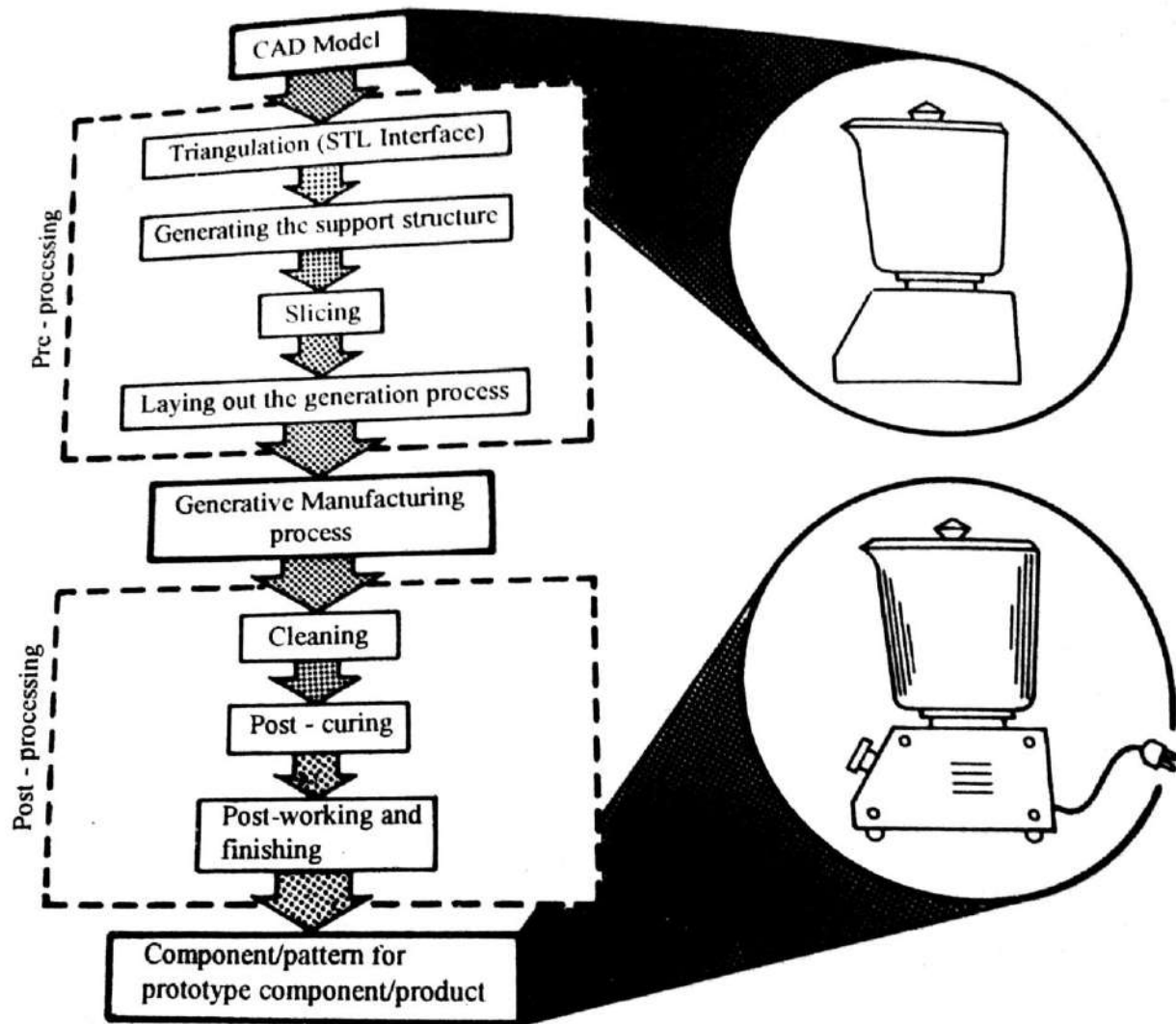

Steps involved in rapid prototyping

Process chain in RP in integrated CAD-CAM environment

- In all commercially developed and technically demonstrated GMP till date the development of part is done by the slicing technique.
- However a direct 3-dimensional building up technique is also under active consideration. In this technique it will not be necessary to define the part in terms of thin layers and the process will not require the generation of lower part before the upper part is generated.
- Thus, the freedom and flexibility in shape creation and enhanced, but it puts a great burden on programming the generating equipment.

The figure below shows the whole process chain of rapid product development using RP technique.

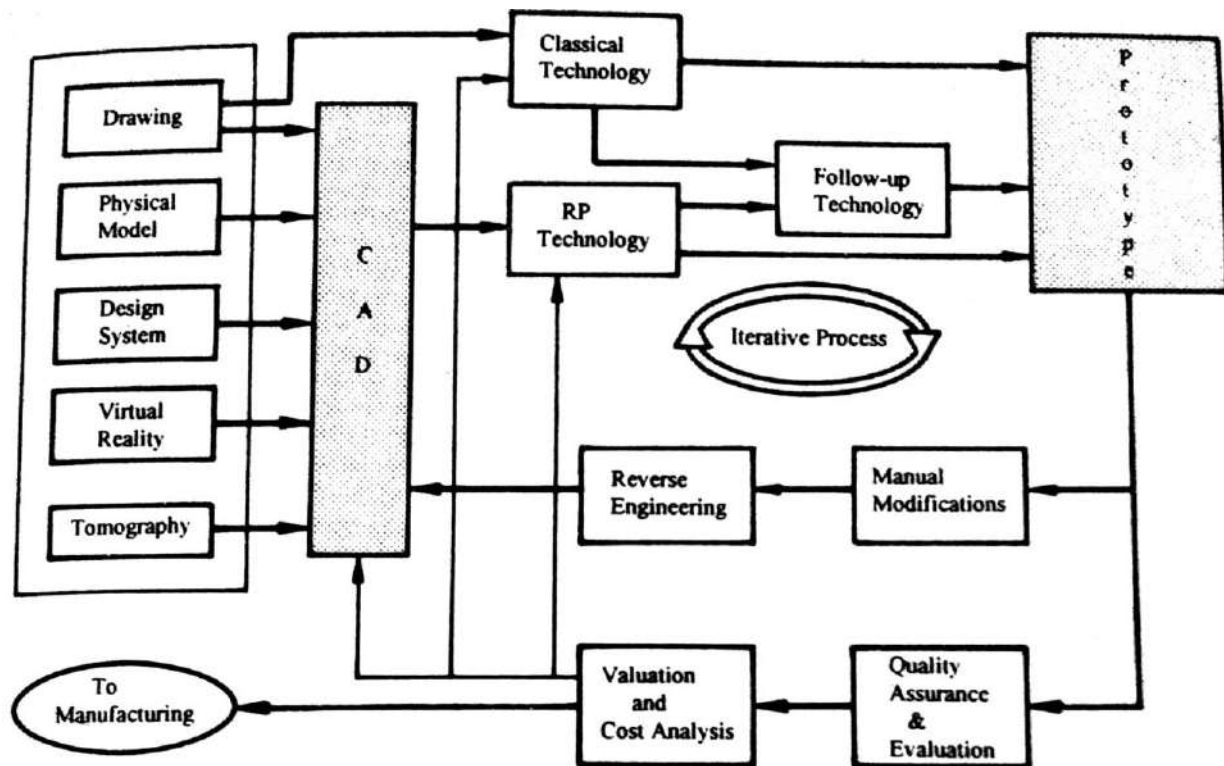

Process chain for rapid prototype development

Advantages and disadvantages of rapid prototyping

Subtractive type RP is typically limited to simple geometries due to the tooling process where material is removed. This type of RP also usually takes a longer time but the main advantage is that the end product is

fabricated in the desired material. Additive type RP, on the other hand, can fabricate most complex geometries in a shorter time and lower cost. However, additive type RP typically includes extra post fabrication process of cleaning, post curing or finishing.

Here is some of the general advantages and disadvantages of rapid prototyping :

Advantages:

- Fast and inexpensive method of prototyping design ideas
- Multiple design iterations
- Physical validation of design
- Reduced product development time

Disadvantages:

- Resolution not as fine as traditional machining (millimeter to sub-millimeter resolution)
- Surface flatness is rough (dependant of material and type of RP)

Rapid Manufacturing Process Optimization: factors influencing accuracy

Accuracy of a model is influenced by the errors caused during tessellation and slicing at data preparation stage. Decision of the designer about part deposition orientation also affects accuracy of the model.

Errors due to tessellation: In tessellation surfaces of a CAD model are approximated piecewise by using triangles. It is true that by reducing the size of the triangles, the deviation between the actual surfaces and approximated triangles can be reduced. In practice, resolution of the STL file is controlled by a parameter namely chordal error or facet deviation as shown in figure 2. It has also been suggested that a curve with small radius (r) should be tessellated if its radius is below a threshold radius (r_0) which can be considered as one tenth of the part size, to achieve a maximum chordal error of $(r/r_0)^\alpha$. Value of α can be set equal to 0 for no improvement and 1 for maximum improvement. Here part size is defined as the diagonal of an imaginary box drawn around the part and α is angle control value (Williams et al., 1996).

Errors due to slicing: Real error on slice plane is much more than that is felt, as shown in figure 12(a). For a spherical model Pham and Demov (2001) proposed that error due to the replacement of a circular arc with stair-steps can be defined as radius of the arc minus length up to the corresponding corner of the staircase, i.e., cusp height (figure 12 (b)). Thus maximum error (cusp height) results along z direction and is equal to slice thickness. Therefore, cusp height approaches to maximum for surfaces, which are almost parallel with the x-y plane. Maximum value of cusp height is equal to slice thickness and can be reduced by reducing it; however this results in drastic improvement in part building time. Therefore, by using slices of variable thicknesses (popularly known as adaptive slicing, as shown in figure 13), cusp height can be controlled below a certain value.

Except this, mismatching of height and missing features are two other problems resulting from the slicing. Although most of the RP systems have facility of slicing with uniform thickness only, adaptive slicing scheme, which can slice a model with better accuracy and surface finish without losing important features must be selected. Review of various slicing schemes for RP has been done by Pandey et al. (2003a).

5.2. Part building

During part deposition generally two types of errors are observed and are namely curing errors and control errors. Curing errors are due to over or under curing with respect to curing line and control errors are caused due to variation in layer thickness or scan position

Rapid Manufacturing Process Optimization: factors influencing accuracy. Data preparation errors, Part building errors, Error in finishing, influence of build orientation.

Module - III

Classification of different RP techniques:

A large number of techniques and machines have already been developed in the area of RP and therefore classification/grouping of these processes will be used in presenting descriptions in a structured format. Classification of these processes can be done from two prospective (i) the way material is created/solidified and (ii) the way the shape is generated. A number of processes are still in the R&D stage and some are only in the conceptual stage.

<i>Development of solid object</i>	<i>Basic element of creation</i>	<i>Nature of connectivity</i>	<i>Processes</i>
Two-dimensional layer-by-layer technique	Point	Discrete	<ul style="list-style-type: none"> ● Stereolithography ● Thermal polymerization ● Foil polymerization ● Selective laser sintering ● Selective powder binding ● Ballistic particle manufacturing
		Continuous	<ul style="list-style-type: none"> ● Stereolithography ● Fused deposition modelling ● Shape melting
	Layer	—	<ul style="list-style-type: none"> ● Laminated object manufacturing ● Solid ground curing ● Repetitive masking and depositing
Direct three-dimensional technique	Point	Discrete	<ul style="list-style-type: none"> ● Beam interference solidification ● Ballistic particle manufacturing
		Continuous	<ul style="list-style-type: none"> ● Fused deposition modelling ● Shape melting
	Surface	—	<ul style="list-style-type: none"> ● Holographic interference solidification
	Volume	—	<ul style="list-style-type: none"> ● Programmable moulding

Classification of RP based on layering technique (2D or 3D)

<i>State of material</i>	<i>Type</i>	<i>Mechanism</i>	<i>Energy type</i>	<i>Energy source</i>	<i>Process</i>
Liquid	Photo-polymers	Liquid photo-polymerization	Monochromatic light	Lamp	Solid ground curing (SGC)
				Laser beam	Stereolithography (STL)
				Holography	Holographic interference solid (HIS)
			Light (two frequencies)	Two laser beams	Beam interference solidification (BIS)
	Thermosetting polymer	Liquid thermal polymerization	Heat	Laser beam	Thermal stereolithography (TSTL)
	Non-metals	Melting and solidification	Heat	Heated nozzle	Fused deposition modelling (FDM)
					Ballistic particle manufacturing (BPM)
	Metals	Melting and solidification	Heat	Electric arc	Shape melting
Laser beam				Fused deposition modelling (FDM)	
Electrochemical discharge				Fused deposition modelling (FDM)	

<i>State of material</i>	<i>Type</i>	<i>Mechanism</i>	<i>Energy type</i>	<i>Energy source</i>	<i>Process</i>
Solid	Thin sheets and foils	Selective gluing and cutting	Adhesive bonding and cutting	Glue and laser beam	Laminated Object manufacturing (LOM)
	Semi-polymerized plastic foils	Foil polymerization	Light	Lamp	Solid foil polymerization (SFP)
Powder	Single component	Selective sintering	Heat	laser beam	Selective laser sintering (SLS)
	Coated powder	Selective sintering	Heat	laser beam	Selective laser sintering (SLS)
	One component and one binder	Selective powder binding	Chemical bond	Fine droplet beam of binder liquid	3D-printing or, MIT process, or, selective powder binding (SPB)

Classification of RP based on state of raw material and energy sources

Steps in RPT

- Creation of the CAD model of the (part) design,
- Conversion of the CAD model into Standard Tessellation Language (STL) format,
- Slicing of the STL file into thin sections,
- Building part layer by layer,
- Post processing/finishing/joining.

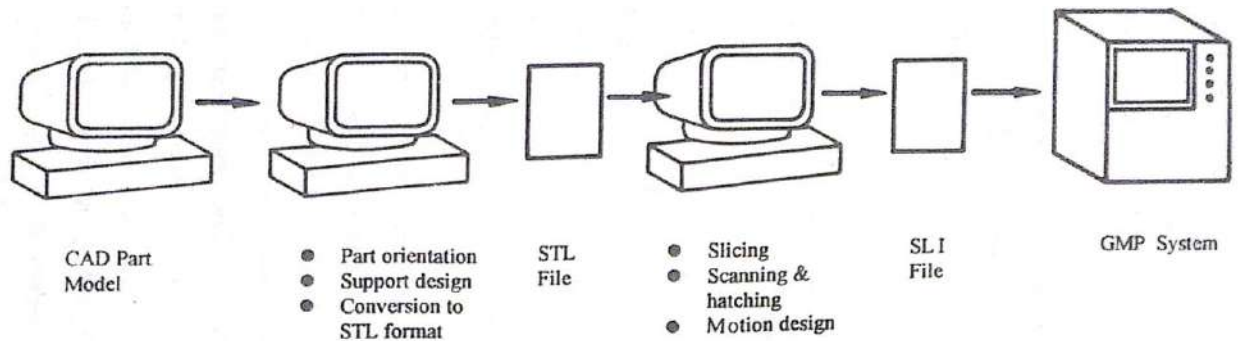

Pre-processing of CAD data

Stereolithography (STL/SLA) with photopolymerization

- RP process for fabricating a solid plastic part out of a photosensitive liquid polymer using a directed laser beam to solidify the polymer
- Part fabrication is accomplished as a series of layers, in which one layer is added onto the previous layer to gradually build the desired 3-D geometry
- The first addition RP technology -introduced 1988 by 3D Systems Inc. based on the work of Charles Hull
- More installations of STL than any other RP method

Some Facts about STL

- Each layer is 0.076 mm to 0.50 mm (0.003 in to 0.020 in.) thick
 - Thinner layers provide better resolution and more intricate shapes; but processing time is longer
- The starting materials are liquid monomers
- Polymerization occurs upon exposure to UV light produced by helium-cadmium or argon ion lasers
 - Laser scan speeds typically 500 to 2500 mm/s

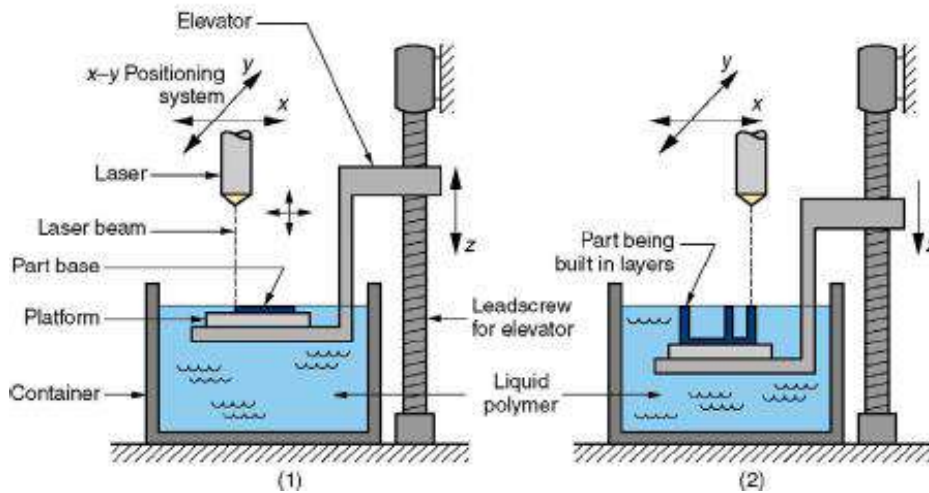

Stereolithography: (1) at the start of the process, in which the initial layer is added to the platform; and (2) after several layers have been added so that the part geometry gradually takes form



A part produced by Stereolithography

Once the first layer is cured the platform is lowered by distance equal to the thickness of a layer. Then the laser beam scans the next cross section. The cycle is repeated till the topmost layer of the object is generated.

Subsequently the generated object is removed from the vat and ultrasonic cleaning removes excess material from crevices and openings. An alcohol bath is used to clean any unused polymer. The process of post curing is carried out by applying intense long wave UV radiation to solidify an uncured liquid trapped in the honeycomb like structures.

In most stereolithography machines solidification occurs in a point-by-point fashion. In some cases solidification takes place curing lines at time. A laser beam scans the liquid surface so that a series of voxels (volume picture cells) get solidified as shown figure below. The voxel size should be adequate to ensure connection with the neighboring voxels and also with the layer solidified prior to the current one.

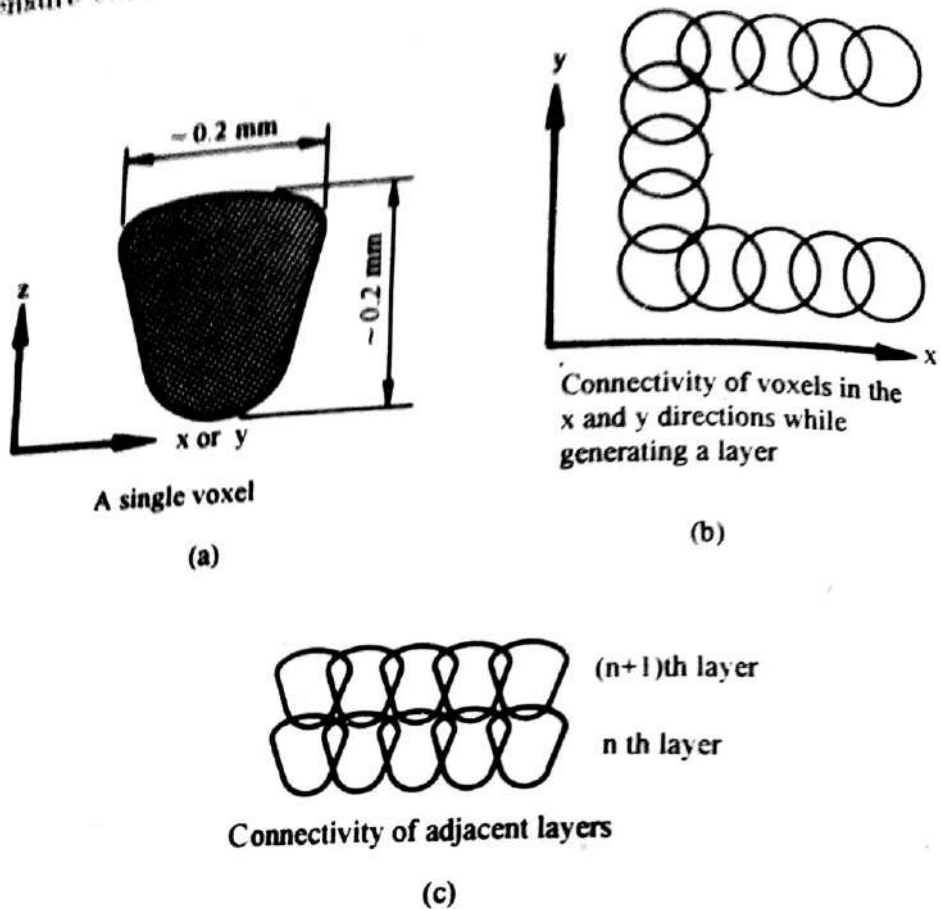

Generation of lines and layers by voxels

The parameter which controls the voxel overlap is the distance between voxels, the laser power, the stay time and the layer thickness. Using high power lasers, continuous lines can be cured forming a solid parabolic cylinder as shown in figure below.

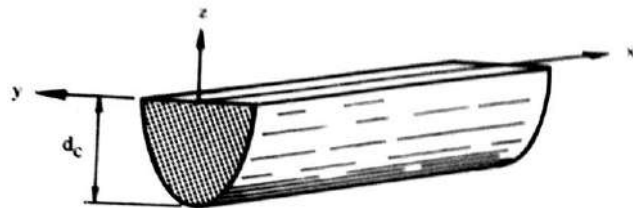

A parabolic prism cured by a laser beam

Solidification due to curing is achieved once the liquid receives the required dose of radiation. The depth of curing will depend on the exposure and the properties of liquid used.

$$d_c = d_p \ln \left(\frac{E_o}{E_c} \right)$$

Where: d_c the depth of a single cured line

d_p the penetration depth of the resin

E_o the centerline exposure on the surface

E_c the critical exposure to which the resin remains liquid

Stereolithography with liquid thermal polymerization:

- This process solidifies the desired object layer by layer using a liquid polymer as in the case of stereolithography.
- The primary difference lies in the process of solidification. Unlike the stereolithography process a thermosetting liquid polymer is used in place of photo polymer and the solidification process depends upon heat not light.
- In this process a 5W Ar-Ion laser is used.
- Post curing is done in an oven at 400°C and the speed of operation is not much different from that in case of SL.
- In a system based on liquid thermal polymerization, that dissipation of heat has to be considered carefully for proper control of the voxel size and accuracy.
- Thermal shrinkage and distortion can also cause problems in quality control.
- However experts think that this problem is not any more severe than that posed by polymerization shrinkage present in other SL operations.
- The shrinkage is of the order of 5-6% in volume i.e about 1.6 to 1.8% in linear dimension.

Stereolithography with Solid Foil Polymerization:

- In this process solid to solid polymerization is employed rather than liquid to solid polymerization as in most SL systems.
- The raw material consists of semi polymerized plastic foils instead of liquid resins.
- Layer upon layer building process involves applying a foil to the newly created, topmost, layer of the object and then polymerizing the required area by a scanning light beam.

- The illuminated portions polymerize further and stick to the layer underneath. The illuminated portions also become insoluble due to polymerization. So the unexposed portion can be removed later by dissolving them and the part with required shape and size will emerge.
- Though the raw material is in the form of thin foils, the process should not be confused with the process of laminated object manufacturing. The actual creation is still done point by point (or Line by line) instead of cutting along the boundaries of a cross section.

Solid Ground Curing (SGC)

- Like stereolithography, SGC works by curing a photosensitive polymer layer by layer to create a solid model based on CAD geometric data
- Instead of using a scanning laser beam to cure a given layer, the entire layer is exposed to a UV source through a mask above the liquid polymer
- Hardening takes 2 to 3 s for each layer

A mask is generated by electro-statically charging a glass plate with negative image of cross section of the required part. In the meantime, a thin liquid polymer is spread across the surface of the work-plane. The mask plate with a negative image of the liquid polymer is positioned over the thin polymer layer and exposed under the ultraviolet laser lamp for few seconds.

All parts of the exposed photopolymer layer get solidified with one exposure. However, the area shaded by the mask is left in a liquid form and is wiped off with vacuum suction head and replaced by hot wax which acts as a support to the solidified polymer layer. A face mill makes the surface of wax and polymer flat and to desired thickness. All the above steps are repeated till final model embedded in removable wax is obtained.

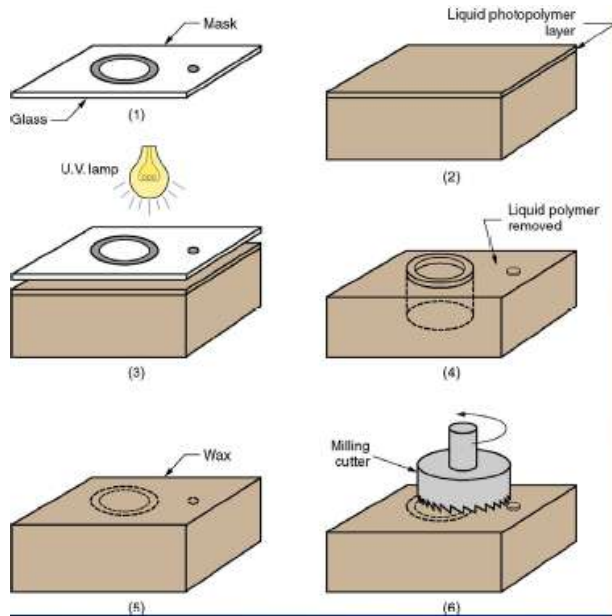

SGC steps for each layer:
 (1) mask preparation,
 (2) applying liquid photopolymer layer,
 (3) mask positioning and exposure of layer,
 (4) uncured polymer removed from surface,
 (5) wax filling,
 (6) milling for flatness and thickness

Facts about SGC

- The sequence for each layer takes about 90 seconds
- Time to produce a part by SGC is claimed to be about eight times faster than other RP systems
- The solid cubic form created in SGC consists of solid polymer and wax

Selective laser sintering (SLA)

SLS was patented in 1989. *The basic concept of SLS is similar to that of SLA.* It uses a moving laser beam to trace and selectively sinter powdered polymer and/or metal composite materials. The powder is kept at elevated temperature. Unlike SLA, *special support structures are not required* because the excess powder in each layer acts as a support.

With the metal composite material, the SLS process solidifies a polymer binder material around steel powder (diameter ca. 0.1 mm) one slice at a time forming the part.

The part is then placed in a furnace (>900 °C), where the polymer binder is burned off and the part is infiltrated with bronze to improve its density.

SLS allows for a wide range of materials, including nylon, glass-filled nylon, Truform (investment casting) and metal composites.

Abbreviation:	SLS
Material type:	Powder(Polymer)
Materials:	Thermoplastics: Nylon, Polyamide and Polystyrene; Elastomers ; Composites
Min layer thickness:	0,10mm
Surface finish:	Average
Build speed:	Fast
Applications:	Form/ fit testing, Functional testing, Less detailed parts, Parts with snap-fits & living hinges, High heat applications..

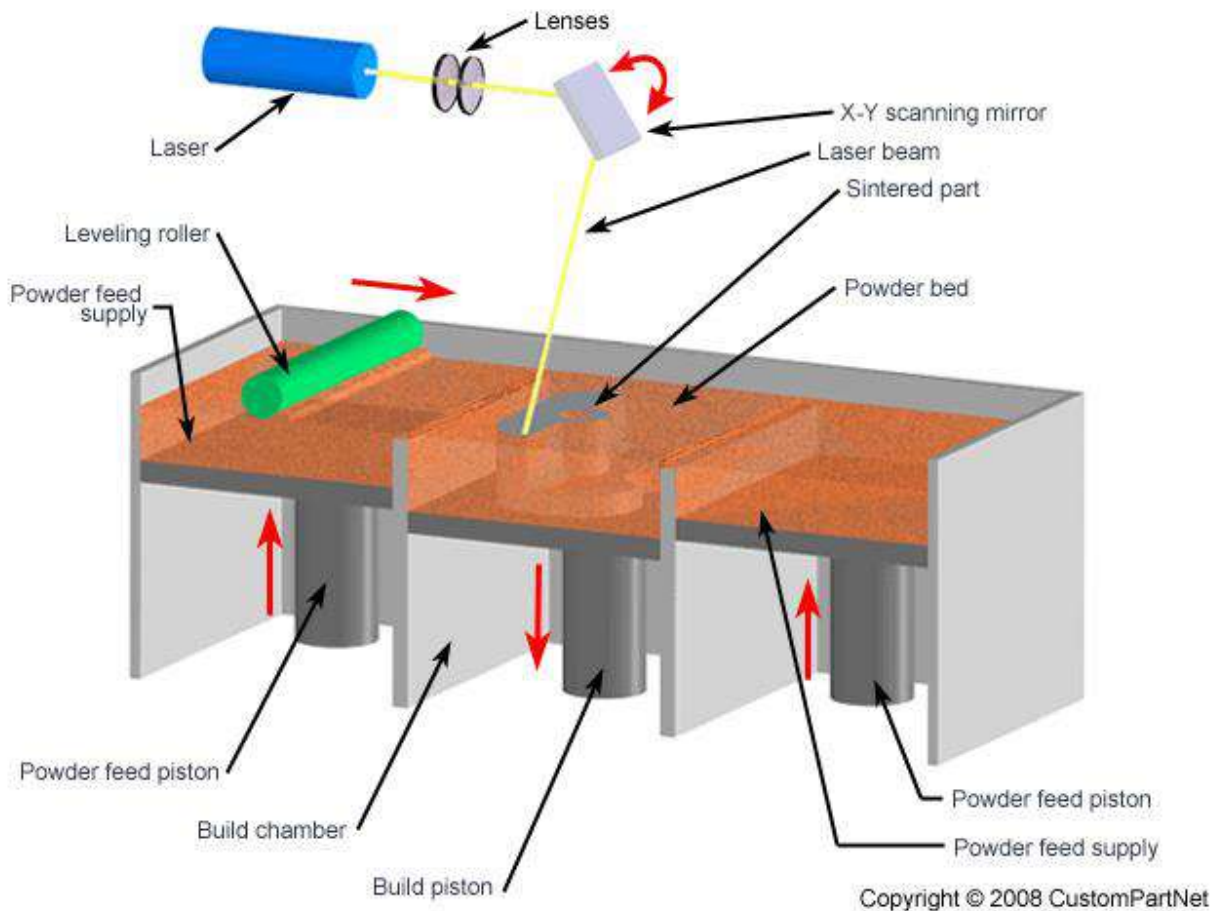

The parts produced by sintering of powder are porous. Those produced by sintering polyvinyl chloride have a relative density of only 60% (i.e. 40% of the part volume in air). New models of SLA machines are being developed

in which ceramic and metal powders can be used. One distinct advantage of SLS is that different materials can be used while building a single part. For cases where higher energy may be required a high energy electron beam is proposed to be used for sintering/melting.

Almost all RP techniques produces a vertical 'stair step' surface finish as shown in figure below, since parts are built by creating discrete layers. The surface of parts produced by SLS process suffer additionally from roughness problems.

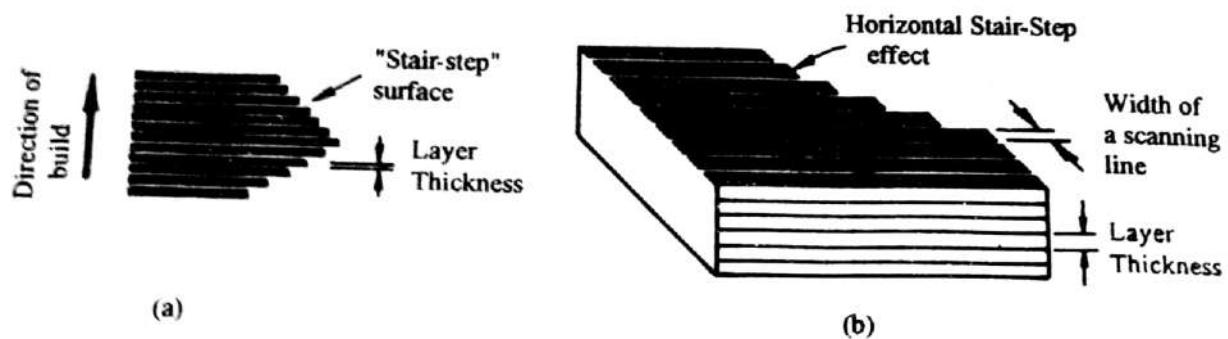

Vertical and Horizontal stair-step effect

- One reason is the nature of the raw material, which is powder. Since sintering does not cause complete melting of the grains (where diameter lies in the range 80micron to 120 micron) the surfaces acquire a granular structure.
- Besides this raster0scan laser drawing also results in horizontal stair-step effect as shown in figure above.
- However to distribute the roughness evenly on all surfaces the orientation of raster is rotated by 90⁰ on alternate layers.
- Further improvement of surface finish is possible by outlining each cross section prior to the drawing of rasters. But the last technique results in higher part building time.

Selective powder binding (SBP)

In this system, in order to build a part, the machine spreads a single layer of powder onto the movable bottom of a build box. A binder is then printed onto each layer of powder to form the shape of the cross-section of the model. The bottom of the build box is then lowered by one layer thickness and a new layer of powder is spread. This process is repeated for every layer or cross-section of the model. Upon completion, the build box is filled with powder, some of which is bonded to form the part, and some of which remain loose. The steps involved in the process are shown in figure below

This process is also called three dimensional printing; being developed by MIT is based on creating a solid object from a refractory powder by selecting binding through the application of a colloidal liquid silica binder.

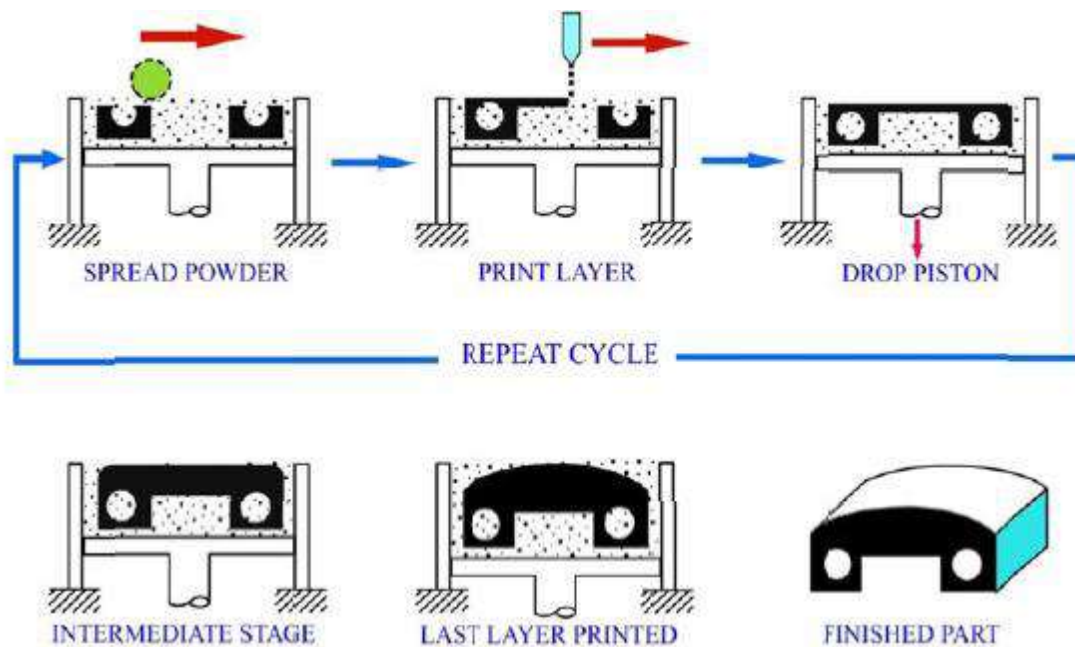

Various stages and steps of selective powder binding (SPB)

In this process a fine jet of ceramic binder is ejected onto the powder layer where solidification is desired. This is done on the inkjet mechanism scans the layer by either ejecting the binder droplets at the identified locations or by deflecting the continuously emerging drops away from the locations where solidification is not wanted. These are termed as 'drop-on-demand' and 'continuous jet' systems respectively.

- The droplets are electrically charged at the nozzle and then deflected by applying suitable voltages to electrodes located below the nozzle.

- The nozzle is moved across the powder surface in a raster scan while computer generated electrical signals control the deposit of the binder.

Figure below shows an ink-jet mechanism schematically. A vacuum is applied to the reservoir such that a negative head pressure is maintained at the face plate. Capillary force at the face plate orifice prevents the binding liquid from being pulled in through the mechanism. The mechanical impulse created on applying electrical charge to the piezoelectric crystal produces a shock wave which causes the ejection of a droplet from the face plate.

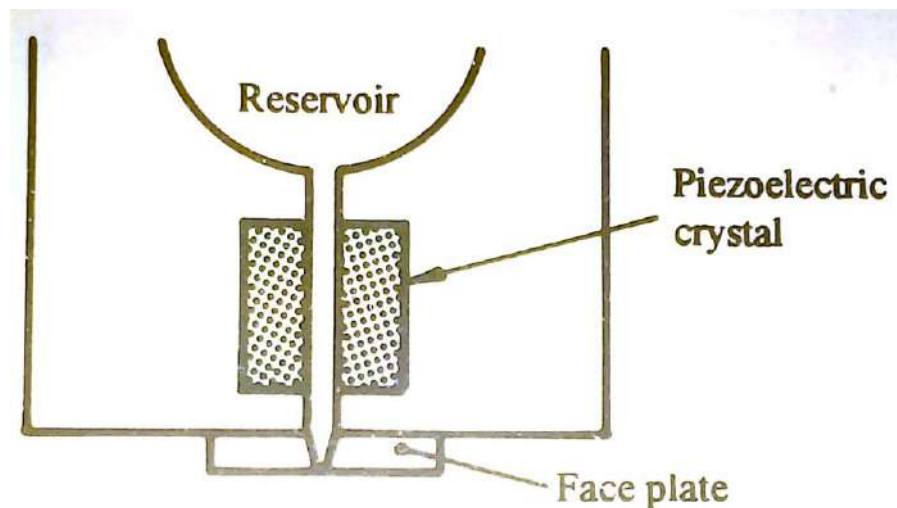

Schematic view of an ink-jet mechanism

The print head consists of an array of a large number of jet ports each one capable of operating at 10KHz. With an array of high frequency jets, the layer solidification time can be 4s/layer for a drop on demand system with a layer size of 0.5m \times 0.5m. it can be as low as a fraction of a second for 'continuous jet' system.

The major problem with the parts produced by this technique is inadequate surface finish. Removal of unbound powder from narrow passages and enclosed cavities also poses difficulties. This process is however, very convenient for making moulds with integral cores. Since the fabrication of the mould and the core is done as a single unit, the registration of cores to the mould is precise.

Ballistic Particle Manufacturing(BPM) – both 2D and 3D,

Perception Systems Inc. has developed the ballistic particle manufacturing technique for creating three-dimensional solid objects from the computer model directly. As the name suggests, parts are produced by shooting droplets of molten material at required places. As in the selective powder binding process, here also material is supplied through an array of drop-on-demand ink-jet ports. Molten wax droplets, approximately $50\mu\text{m}$ in diameter, are ejected at rates upon 12,500 droplets per second. BPM is possible for both layer-by-layer two-dimensional fabrication and direct three-dimensional fabrication. The two-dimensional layer-by-layer process is based on generating layers by the wax droplets. Figure 4.9(a) shows the CAD model and in Figure 4.9(b), the support structures have been added. The usual slicing of this part-support integrated model yields two-dimensional layers a portion of which belongs to the part to be generated and the rest to the support structure (Figure 4.10(a) and (b)). The part is generated from wax whereas the support is developed from polyethylene glycol, a synthetic wax that is soluble in water. The deposition of wax and polyethylene glycol is done by sorting droplets from an array of 32 piezoelectric ink jet ports operating at 10 kHz. On contact with the previously generated layer, the hot droplets momentarily melt the contact surface of the previously deposited layer. On subsequent cooling and solidification, a homogeneous material is formed of the desired shape. After all the layers have been deposited, the object

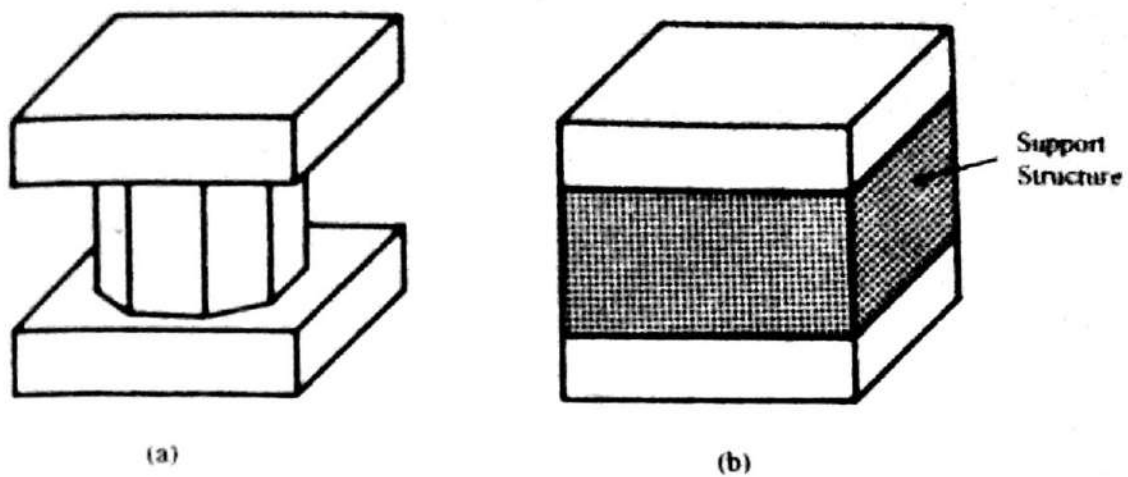

Figure 4.9: (a) CAD model of part (b) CAD model of part-cum-support

is placed in a warm water bath to dissolve the support material, leaving the desired object. The finished part is removed from the bath and cleaned.

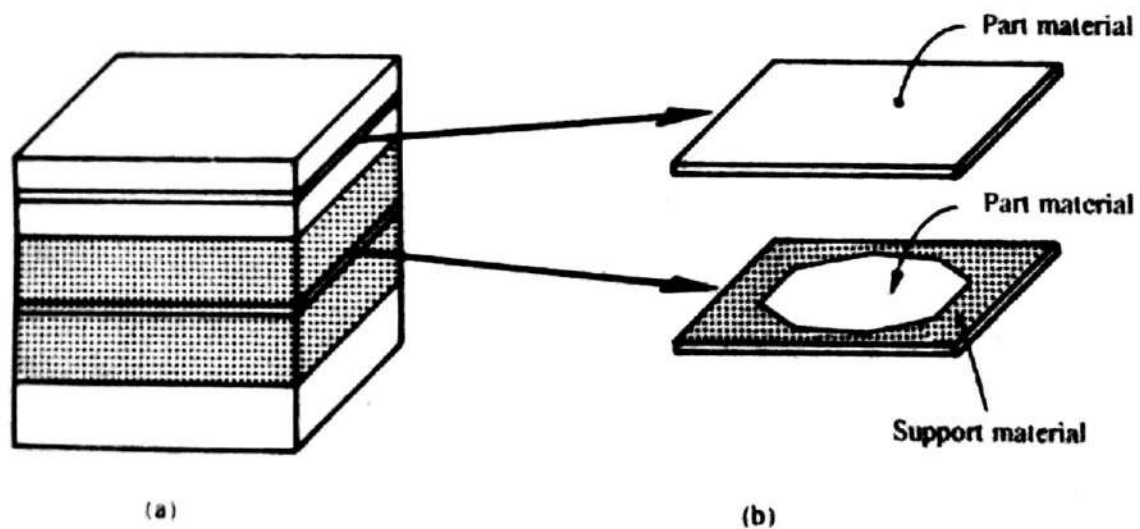

Figure 4.10: (a) Slicing of model (b) Layers showing part and support material arrangement

The accuracy depends on the accuracy of depositing wax drops which is dependent on the location of the piezoelectric jet system, and the ballistic paths of the individual droplets. Thus, it is important for the jet ports to be as close to the substrate as possible to allow for a random droplet dispersion angle of upto 5° . The layer thickness is monitored by a feedback loop with proximity sensors measuring the distance between the jet ports and the substrate (previously deposited layer). If this distance is found to be more than the set value the frequency of droplets (i.e., the flow rate of material) is increased so as to increase the layer thickness within the operating window. In the currently available systems, parts have been generated with $90\ \mu\text{m}$ layer thickness.

As the support structure is removed by dissolving it in warm water it is essential to ensure that the support structure material is not completely enclosed by the part material. Small holes provided in such cases are usually adequate to allow the support material to be dissolved from internal cavities. The wax models produced by this technique can be very useful for investment casting.

Fused deposition modeling,

Fused deposition modelling produces three-dimensional objects by depositing a molten thermoplastic material layer by layer. The Stratasys Inc. is commercially manufacturing units for FDM. A solid filament of thermoplastic material with 1.25 mm diameter is fed into an xy controlled extrusion head. The material is melted (at 180°F, about 1°F above its melting temper-

ature) by a resistance heater. As the head is guided along the required path under computer control, the thermoplastic material is extruded through a nozzle by a precision volumetric pump. The extruded material, deposited as a fine layer, being just above the melting temperature, resolidifies by natural cooling within 1/10th of a second. Building up of the desired object is achieved through deposition of such fused layers. To ensure proper adhesion of the deposited fused material with the previously deposited layer, the model temperature is maintained just below the solidification temperature. After every layer is deposited, the piston (upon which the model is built) is lowered by one layer thickness. Figure 4.11 shows the process schematically.

The flow rate of the extruded molten filament is accurately controlled and matched with the travelling speed of the depositing head (which can be as high as 380 mm/sec), the desired thickness of the layer (in the range 0.025 mm to 1.25 mm) and the width of the extruded layer which may vary from 0.23 mm to 6.25 mm. The repeatability and positional accuracy of this process are claimed to be about ± 0.025 mm with an overall tolerance of 0.125 mm over a cube with 305 mm sides. However, the parts produced by FDM show some roughness and the process may not be suitable for parts with smaller details.

Theoretically, any thermoplastic material may be suitable for the process. Parts built up with different materials or colours can be conveniently produced by this process. The typically used materials for FDM include investment casting wax, wax-filled plastic adhesive material (machinable wax) and tough nylon-

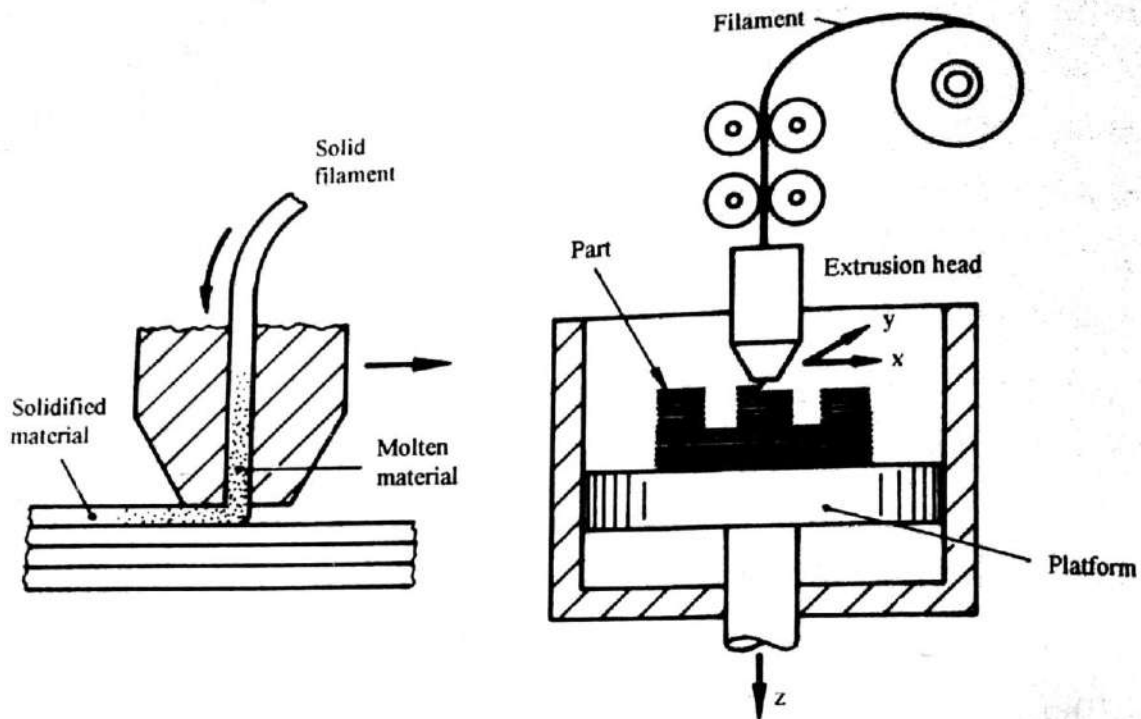

Figure 4.11: Scheme of fused deposition modelling (FDM)

like material. A polymer like material with good strength and flexibility has also been used recently and Stratasys claims that it features improved bonding and surface finish. Parts made from investment casting wax can be directly used for casting. The other materials under development are a silicone rubber sealing material and an automotive body foam material. All these materials are non-toxic and, so, the process is suitable for the office environment.

When the deposition of a layer is completed, the head pauses while the platform indexes downward to make room for the next layer. This results in a seam at the location where the deposition head

head pauses. It is being proposed to develop a system which will provide a quick downward movement when the head is still in motion. This may eliminate the above mentioned problem. It is important that the head be kept in motion at all times. Otherwise material melts near the tip and forms little bumps which may be visible on the surface layers. Temperature control of the FDM head and the part is crucial for the success. There is no wastage of material in this process and parts produced by FDM do not require a major cleaning operation after fabrication.

Shape melting

The process is very similar to fused deposition modeling and was developed by Babcock and Wilcox. The basic idea behind this process is to build parts directly from welding material melted by sticking an arc as in arc welding. This is similar to the technique often used in the industry to repair worn components, broken gear teeth etc. A band or thread of metal is melted and deposited by arc welding and the desired shape is obtained by controlling the position of the welder with the help of a robot. A controlled cooling system is used to ensure fast solidification. With the currently available system, the major limitations are the accuracy and finish. Accuracy better than 1mm is presently not possible. Further there are problems in producing parts of sizes smaller than 7 mm.

The major advantage of this process is that the metal parts produced by this process can be directly used for making functional prototypes. Materials used till date includes Inconel (alloy625), tungsten carbide and other alloy. The advantage also includes high strength isotropic material properties and the possibility of developing multi material parts with tailored properties. Moreover, a uniform fine grained micro structure is produced by this process.

Module – IV

Laminated object manufacturing

This technique is especially suited for producing parts from laminated paper, plastic, metal etc. The schematic of an LOM setup is shown in Fig. 5.2.1. A laser beam cuts the contour of part cross-section. Several such sections when glued or welded yield the prototype. The layers are built up by pulling a long, thin sheet of pre-glued material across the base plate and fixing it in place with a heated roller that activates the glue. Then a laser beam is scanned over the surface and cuts out the outline of that layer of the object. The laser intensity is set at just the level needed to cut through a single layer of material. Then the rest of the paper is crosshatched to make it easier to break away later. The base plate moves down, and the whole process starts again. The sheet of material is made significantly wider than the base plate, so when the base plate moves down, it leaves a neat rectangular hole behind. This scrap material is wound onto a second roller, pulling a new section across the base plate. At the end of the build process, the little crosshatched columns are broken away to free the object. The material used is usually paper, though acrylic plastic sheet, ceramic felts can be used. The LOM is particularly suitable for large models.

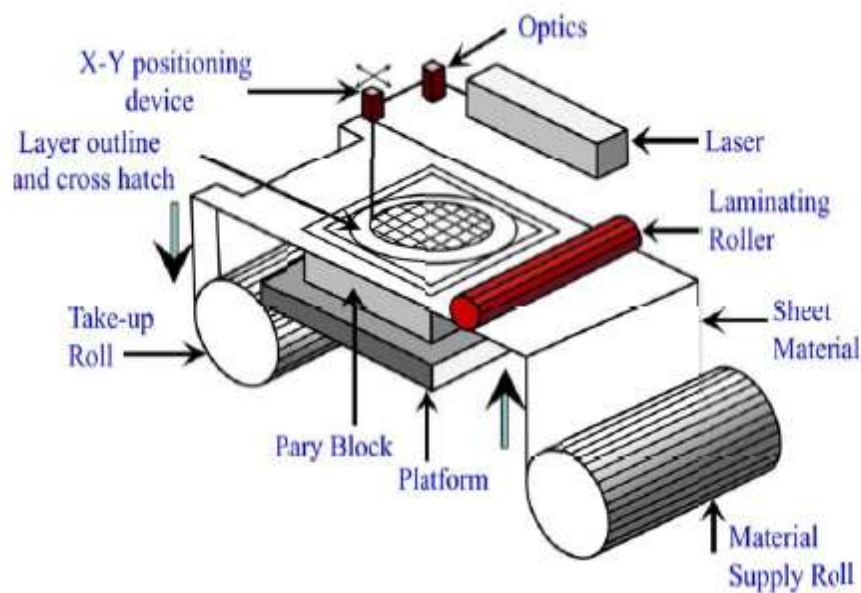

Laminated object manufacturing process

The entire surface of the sheet material is coated with adhesive, therefore each layer adheres to the previously laid layer at all points of contact. Though the laser beam cut the layers to separate a cross section from the ribbon of the work material it cannot separate the layers once they are glued. This results in a problem where an unwanted part of an upper layer remains glued to the previous cross section. Figure (a) shows a tapered object under fabrication by LOM, Fig (b) shows the lamination pattern to be generated by laser cutting and layer deposition.

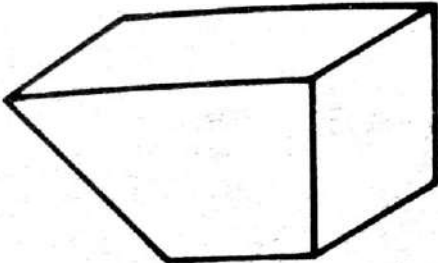

(a)

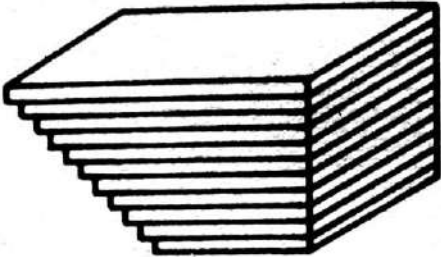

(b)

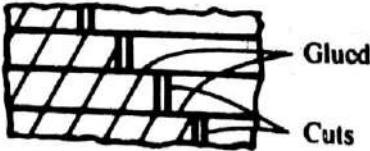
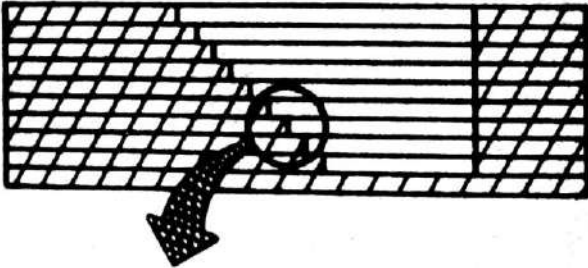

(c)

Inter layer adhesion problem in LOM

Figure c above shows the actual fabrication process and the undesirable gluing between the desired and undesired parts of successive layers. Thus all down facing surfaces of the part tend to adhere to the block and separation becomes difficult after the generation is over. Currently the problem is reduced by a method called burn out. The area on the previously laid layer where gluing is undesirable, is cut with a tightly spaced cross hatch pattern. However this problem of LOM is a serious hurdle till now. Attempt is being made to develop techniques to glue the sheet only within the parts cross section. One way to achieve this is to apply a heat sensitive glue all over the surface and then scan the cross sectional area with a laser beam thus heating and thus gluing the sheets only at the desired area.

Another way to solve this unwanted gluing problem is to use an UV sensitive glue along with. Selective gluing can be achieved by scanning the required area with an UV laser. Another technique is that of printing a mask to the foil and then illuminating with UV lamps through a glass plate pressing the sheet on the stack. The principle is shown below.

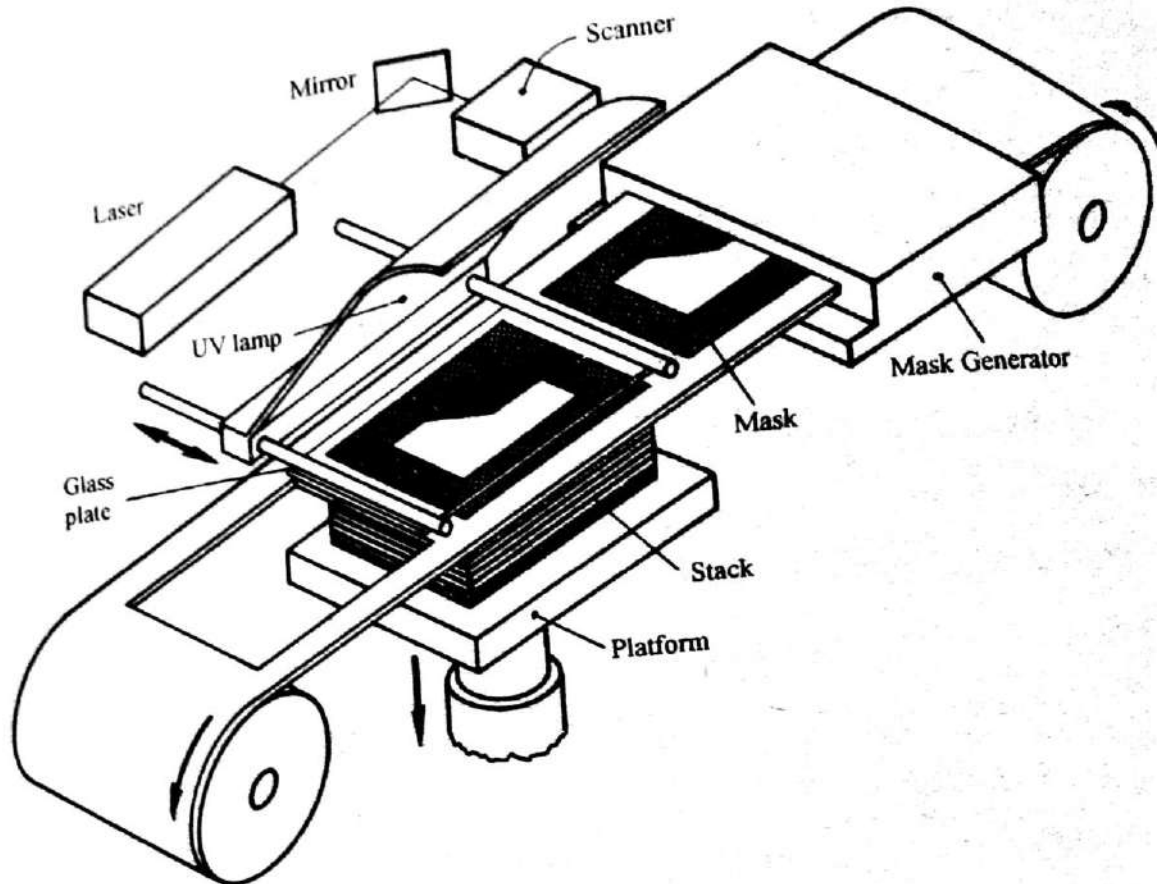

Scheme of using mask and UV lamp for selective gluing

- A hollow part cannot be generated by LOM as the excess material remains trapped inside.
- Such parts can be generated in pieces.
- The difficulty in removing the unwanted material can be resolved by removing the excess material as it is produced on each layer. This is proposed to be done by a vacuum pump to suck away the loosened pieces to get attached to a screen. As the screen is moved to an area without suction the pieces fall into a waste bin. Figure below explain the principle schematically.
- However it is noted that removing the excess material layer wise also eliminate a major advantage of LOM
- Once the part is not build within a block of material, support structure has to be used for supporting cantilevers and disjointed areas.

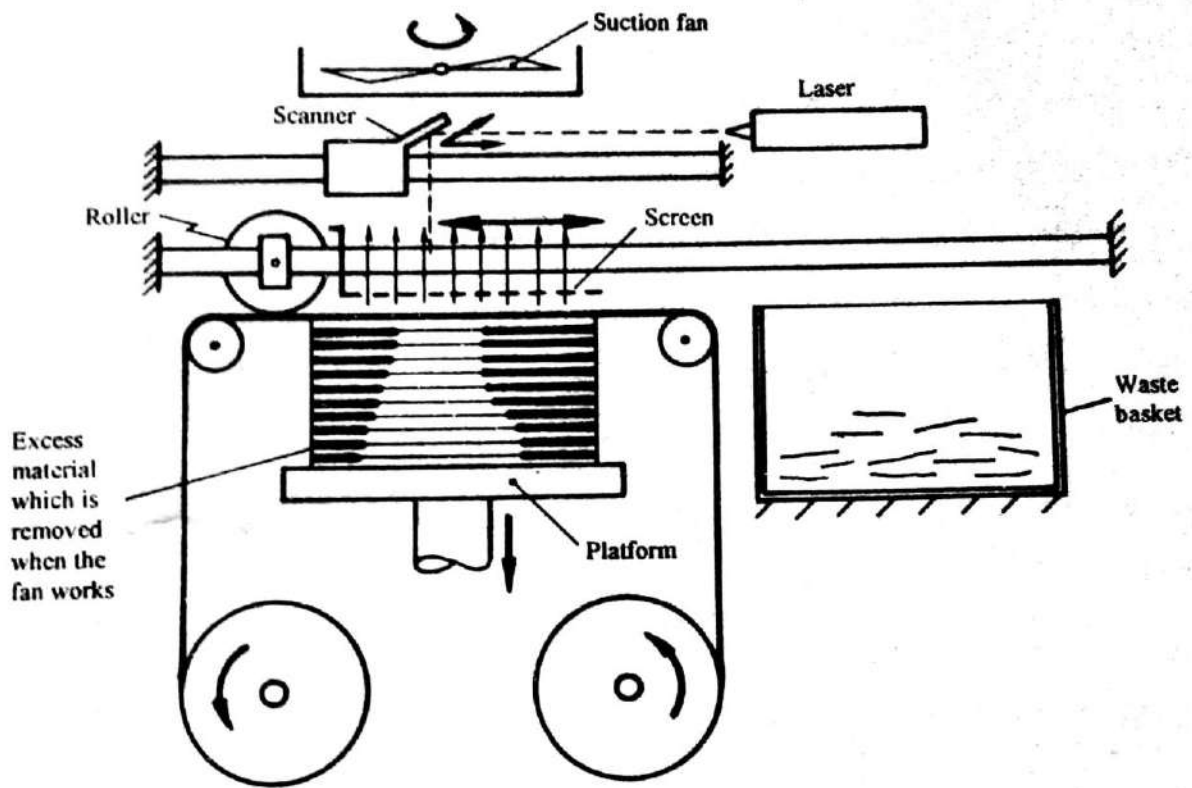

Use of suction fan and screen for removing excess material in LOM

Repetitive masking and deposition

Robotics Institute of Carnegie-Mellon University has developed a GMP based on repetitive masking and depositing which has been given the name MD* (pronounced MD star). In this process a part is built layer by layer by selective deposition of metals from a thermal spray gun. The surface is covered by a stencil (made of thin disposable paper) cut by a laser beam and atomized droplets of the desired metal are sprayed onto the surface. Thus, a thin metal layer gets deposited on the uncovered area, solidifying very quickly, which forms the required layer with the desired cross section. The work area is then covered with a complimentary mask in which the uncut area corresponds to the cross section exposed previously, hence covering the previously exposed area. Next, a thin layer of a low-melting point alloy is deposited by spraying. Thus, a layer of uniform thickness is obtained which constitutes both the sections of the part and the support structure. Figure 4.17 shows the process schematically. The process of masking and spraying is repeated till all

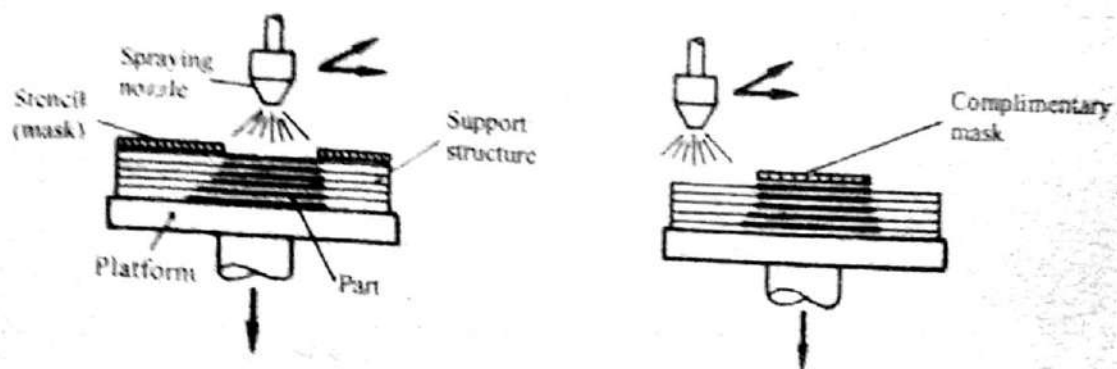

Scheme of MD process

the layers are deposited. The previously deposited layer acts as the substrate for the spray deposition. When all the layers are deposited, the support metal is removed by melting at about 1350°C and the three-dimensional part is obtained. The operation is carried out in either a vacuum or an inert gas atmosphere to prevent formation of oxides which can cause brittleness of the part. Working in vacuum is more difficult but it also eliminates entrapped air during droplet solidification and near zero porosity is obtained.

To maintain uniformity, the metal arc spray gun is manipulated by a robot. Figure 4.18 shows the basic features of a typical arc spray gun. Two spools of metal wire are fed through the electrodes and the two wire tips form the consumable electrodes. A large current is passed through the electrodes, striking an arc which melts the wire tips. The molten metal is atomized and sprayed by a high-velocity air jet directed at the arc. The atomized particles strike the substrate surface where they flatten out and solidify quickly. Parts can be built by the MD* process

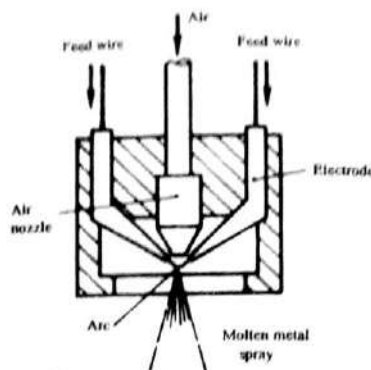

Electric arc spray gun

with layers of 0.03 mm thickness. Since a number of metals can be deposited within the same object, complete assemblies can be fabricated by the process as in the case of SGC process. Even integrated electromechanical systems are possible with integrated circuits inserted during part building and all components are encapsulated within one module. In future the process can be of significant importance in the field of 'mechatronics'.

Masks are made of pressure sensitive paper, cut by lasers, and alignment of each mask is accomplished using registration pins. Very fine features can be produced as spraying of features as narrow as 0.1 mm has been achieved. Furthermore, spray deposition with such fine atomized droplets leads to fabrication

of parts with very little porosity and the resulting density can be higher than 99%.

Due to shrinkage on cooling, residual stresses may be generated which remain locked in the part. Shot peening of the deposited layers during the process can help reducing these stresses.

Beam Interference Solidification (BIS)

This early method for creating three-dimensional objects directly was patented by Formiographic Engine and Batelle participated in its development in the sixties. The material which is used in the process is a photo sensitive transparent liquid plastic (monomer). When the liquid is hit by a laser beam of a specific frequency, it reaches a reversible meta stable state and no bonding reaction takes place. But when a part of the liquid that is already in such a meta stable state is hit by another laser beam of a specific but different frequency, polymerization of the meta stable state takes place resulting in solidification of a voxel represented by the intersection of the two beams. Such a liquid resin is kept in a transparent vat and two laser beams are placed on adjacent sides (as shown in Figure 4.19) with the beams at right angles to each other. Pattern creation takes place by solidifying the resin at the point of intersection of the two beams

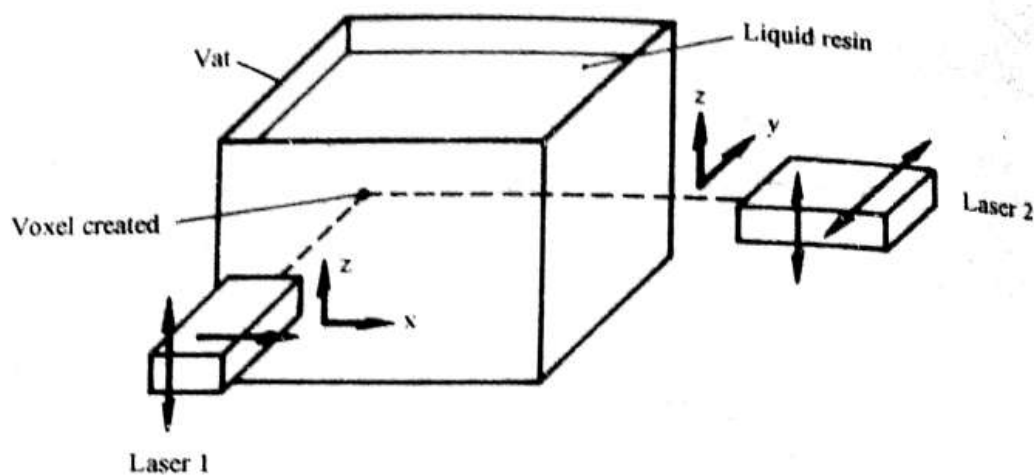

Principle of Beam Interference solidification

and by moving the laser beams so that their point of intersection traces the required volume.

Though the principle is conceptually very elegant, till now it has not found much practical application because of a number of serious difficulties. The intensity of beam decreases continuously during its passage through the resin because of absorption. This makes it difficult to programme the laser beam movement so that all voxels are of uniform characteristics. The problem is further complicated because of shadow effects produced by the parts already **solidified**. To overcome this, an elaborate planning of **beam movement** is necessary to avoid the formation of a voxel after the front portion is solidified. This eliminates a **major advantage** the direct three-dimensional fabrication techniques **claim to possess** over the two-dimensional layer-by-layer building processes.

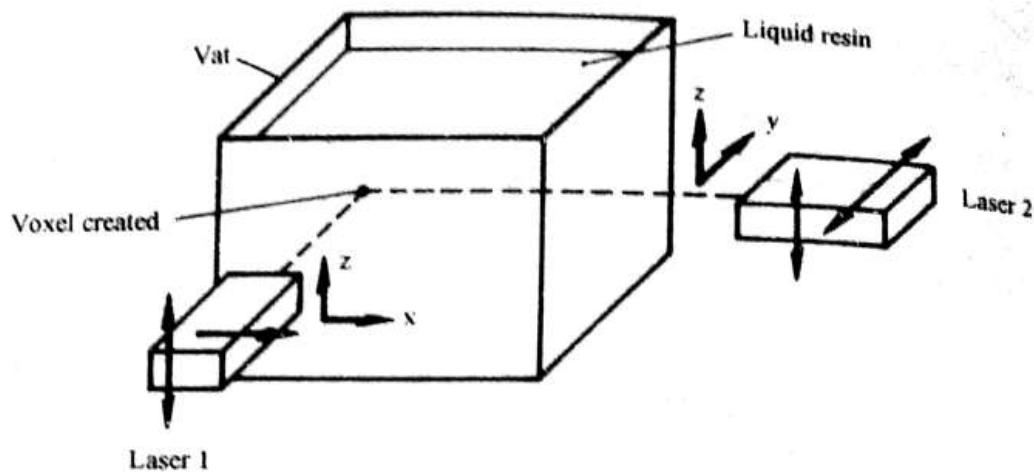

Figure 4.19: Principle of beam interference solidification

Beam Interference Solidification (BIS)

This early method for creating three-dimensional objects directly was patented by Formiographic Engine and Batelle participated in its development in the sixties. The material which is used in the process is a photo sensitive transparent liquid plastic (monomer). When the liquid is hit by a laser beam of a specific frequency, it reaches a reversible meta stable state and no bonding reaction takes place. But when a part of the liquid that is already in such a meta stable state is hit by another laser beam of a specific but different frequency, polymerization of the meta stable state takes place resulting in solidification of a voxel represented by the intersection of the two beams. Such a liquid resin is kept in a transparent vat and two laser beams are placed on adjacent sides (as shown in Figure 4.19) with the beams at right angles to each other. Pattern creation takes place by solidifying the resin at the point of intersection of the two beams

and by moving the laser beams so that their point of intersection traces the required volume.

Though the principle is conceptually very elegant, till now it has not found much practical application because of a number of serious difficulties. The intensity of beam decreases continuously during its passage through the resin because of absorption. This makes it difficult to programme the laser beam movement so that all voxels are of uniform characteristics. The problem is further complicated because of shadow effects produced by the parts already **solidified**. To overcome this, an elaborate planning of **beam movement is necessary to avoid the formation of a voxel after the front portion is solidified. This eliminates a major advantage the direct three-dimensional fabrication techniques claim to possess over the two-dimensional layer-by-layer building processes.**

Holographic interference solidification

The exotic process process is also based on photo polymerization of photo sensitive resins. But in this process the part creation is not done voxel by voxel instead a three dimensional holographic image is projected in a vat containing a photo sensitive liquid monomer and a whole three dimensional surface gets solidified at once. The holographic film for projecting the image is created with a CAD system. A system based on this principle has been developed.

Special topic on RP using metallic alloys

DIRECT METAL LASER SINTERING (DMLS)

DMLS technology was developed jointly by Rapid Prototyping Innovations (RPI) and EOS GmbH in 1994. *It was the first commercial RP-method to produce metal parts in a single process.* Metal powder (20 µm diameter) without binder is completely melted by scanning of a *high power laser beam.* *The density of a produced part is about 98 %.* SLS has about 70 %. One advantage of DMLS compared to SLS is the small size of particles which enables very detailed parts.

Abbreviation:	DMLS
Materialtype:	Powder(Metal)
Materials:	Ferrousmetals such as Steel alloys, Stainlesssteel, Toolsteel; Aluminium, Bronze, Cobalt-chrome, Titanium, Ceramics..
Min layerthickness:	0,02mm
Surfacefinish:	Average
Buildspeed:	Fast
Applications:	Form/fittesting, Functionaltesting, Rapidtooling, Highheatapplications, Medicalimplants, Aerospaceparts..

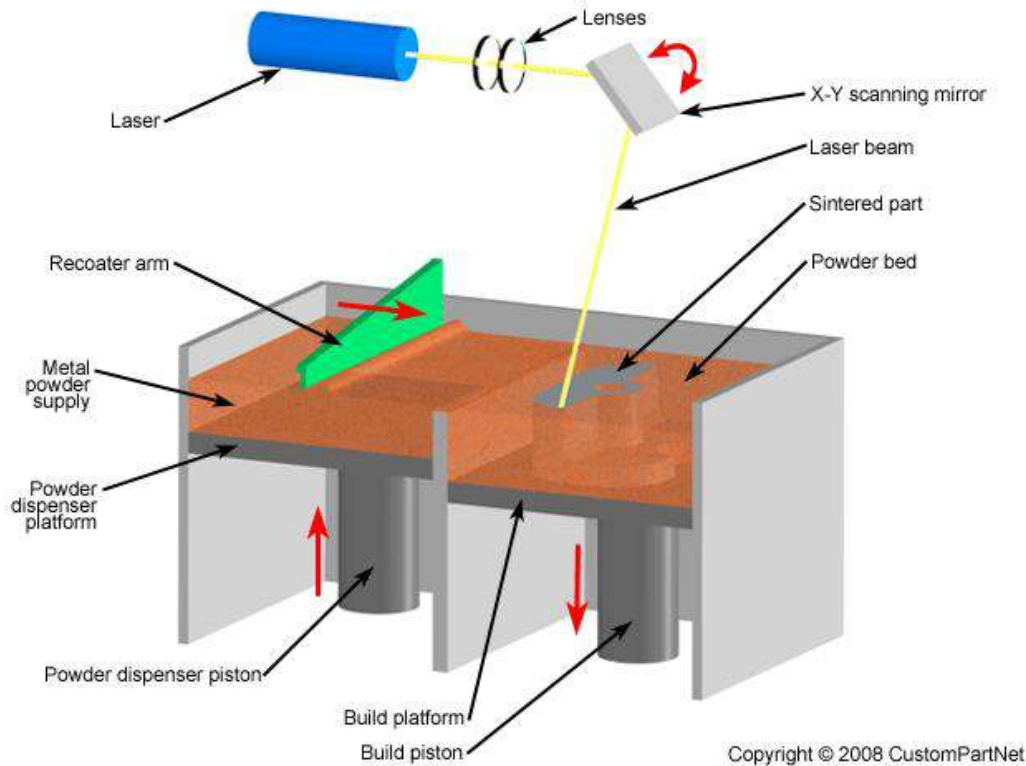

Slicing

The slice programme converts the three-dimensional object in the STL file into two-dimensional cross-sections. The slice axis is defined as the normal to the plane created by slicing and this is also the build direction while creating the part by GMP. The thickness of slice dictates the texture, accuracy and build time. The layer thickness is normally in the range 0.0625 mm to 0.75 mm. It is, however, not correct to assume that using thicker layers (and reducing the number of layers) leads to reduced build time in all cases. In many processes the speed of scanning of the activating element (laser beam in many processes) depends greatly on the layer thickness. So, the time required for creating individual layers increases greatly when large thickness is used. Figure 3.6 shows the typical characteristics of how the build time changes when the layer thickness is gradually increased for three different power levels of the beam used. It is seen that the range

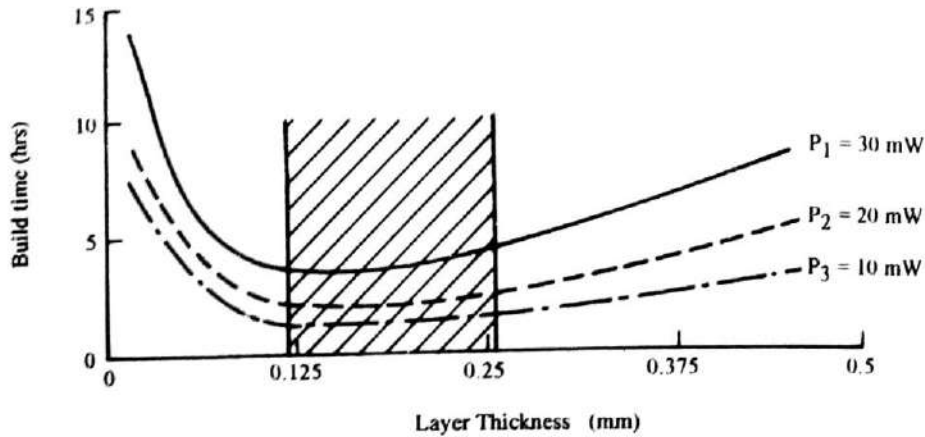

Figure 3.6: Effect of layer thickness on build time

0.125 mm to 0.25 mm is the optimum irrespective of the beam power.

Internal Hatching and Surface Skin Fills

To solidify (or to create) the area inside the part surrounded by the outer boundaries, internal hatching is used to reduce build time. Initially the boundary lines are created and then the interior is criss-crossed with lines, giving the part adequate internal stiffness. The style of hatching can vary. The pattern may consist of parallel lines making 0° , 60° and 120° with the x -axis resulting in an internal structure which consists of equilateral triangles as indicated in Figure 3.7. The spacing between the consecutive lines is about 0.625 mm, and this common hatching pattern is called Tri-Hatch. When liquid photopolymers are used in the process, the material trapped inside the triangles remains liquid till the part is post cured following the comple-

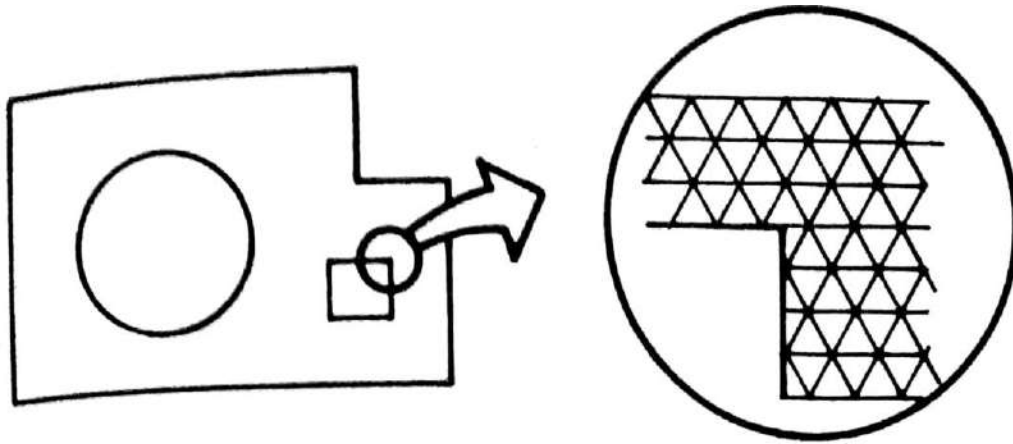

Figure 3.7: Tri-Hatch pattern

tion of the shaping process. Recently, a new pattern has been introduced which is called WEAVETM. In this, the scanning lines are parallel to the x - and y -axis, the spacing being about 0.28 mm when the layer thickness is about 0.25 mm. When the layer thickness is 0.127 mm, the spacing is made to be 0.229 mm. In the Tri-Hatch system too much ($\approx 50\%$) liquid material remains trapped and this leads to considerable post curing distortion. Attempts to reduce the fraction of trapped volume in the Tri-Hatch system by reducing the hatch spacing lead to increased curl distortion. With the WEAVETM system, a reduction of the fraction of trapped residual volume without resulting in large curl distortion is possible.

It is obvious that the outer surfaces of the generated solid cannot end up being porous. Thus, skins are created by skin fills which consist of closely spaced scan lines. The spacing between the scan lines is in the range 0.0762 mm to 0.127 mm. The skin fills are scanned after the borders and internal hatch. However, with the introduction of WEAVETM the importance of skin fill

has been greatly reduced since very little residual liquid remains trapped inside.

Support Design

While slicing the CAD model into layers isolated islands may be produced as shown in Figure 3.8. The sectional view in plane 1-1 shows an isolated island which belongs to a projection from

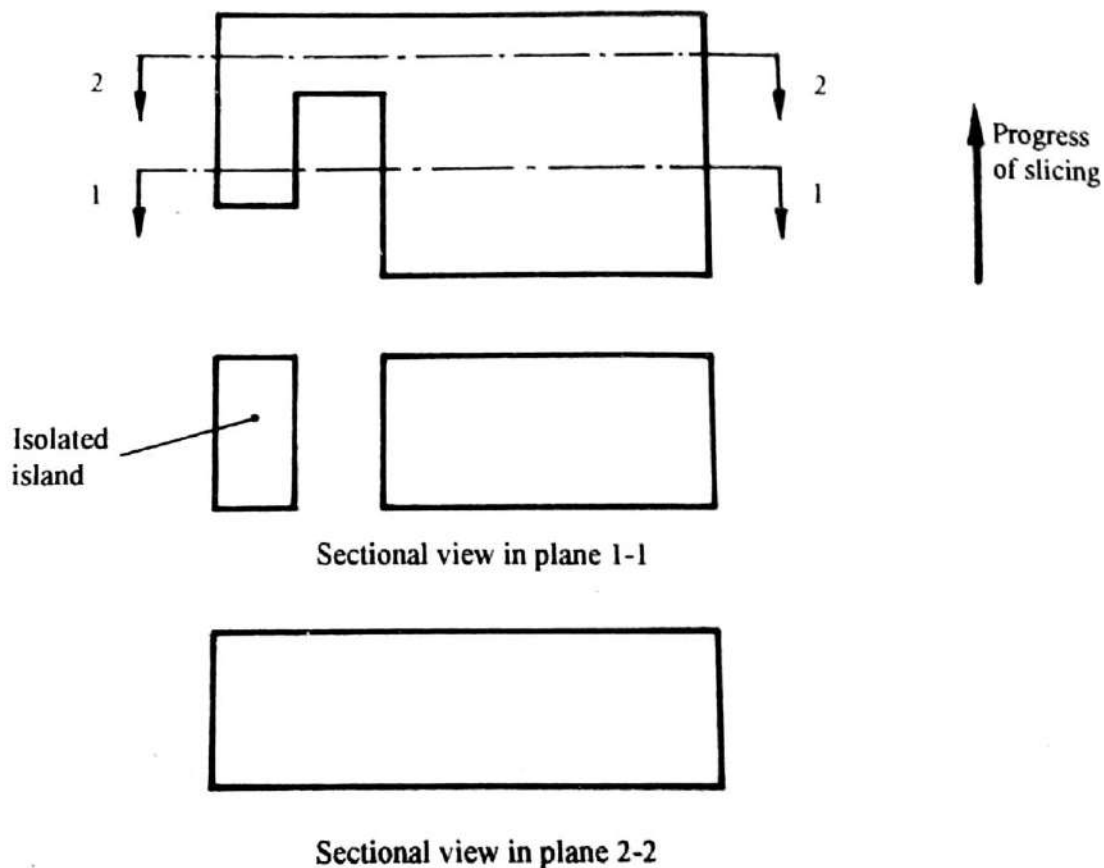
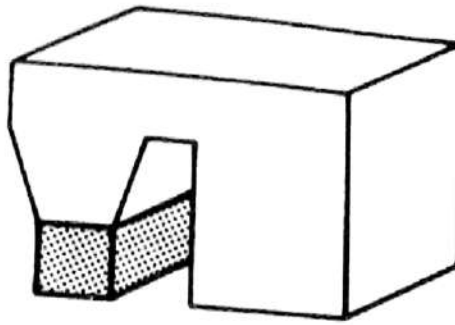
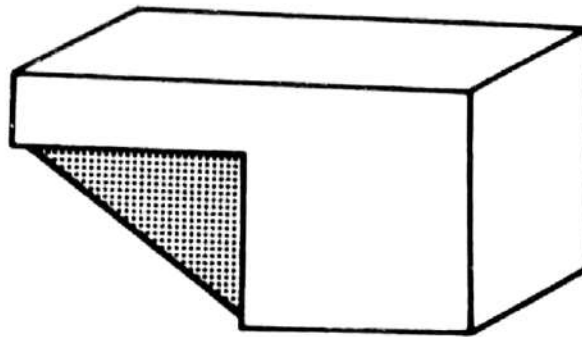

Figure 3.8: Formation of isolated islands

the main object. The connection of the projection to the parent body is from the top and while generating the shape by a GMP it will be built later. Thus it becomes essential to de-



Island



Gussets

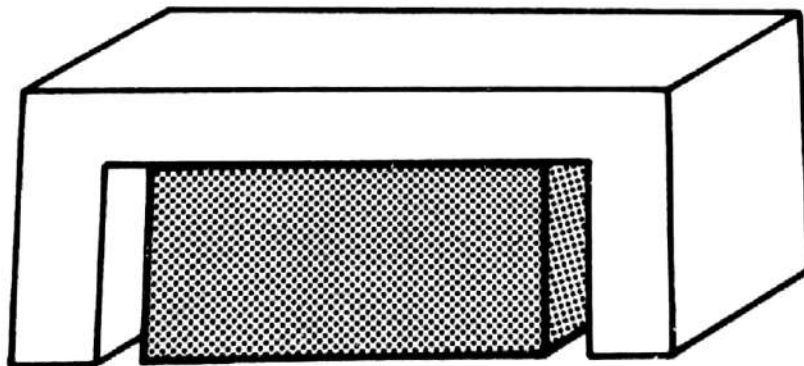

Ceiling

Various types of supports

sign a support for the isolated islands to prevent their fall under gravity, as they are created if the process is liquid-based like Stereolithography. When the whole object is formed the extra supports are removed. Due to similar reasons, supports are essential for long cantilevered projections also. Though isolated islands are not formed, the thickness of the projection may be too thin to support the weight of the cantilever. Thus, supports in a GMP system are analogous to job holding devices for conventional machining. In addition to preventing the fall of isolated islands, supports are generally provided to hold the main part body also. In future suitable materials for GMP may be developed to eliminate the need of supporting the main object. At present supports are essential to hold the material during operation even if the component is devoid of cantilevers and projections. Figure 3.9 shows different types of supports.